

## Installation, Operation and Maintenance Manual

Please read and save these instructions for future reference. Read carefully before attempting to assemble, install, operate or maintain the product described. Protect yourself and others by observing all safety information. Failure to comply with instructions could result in personal injury and/or property damage!

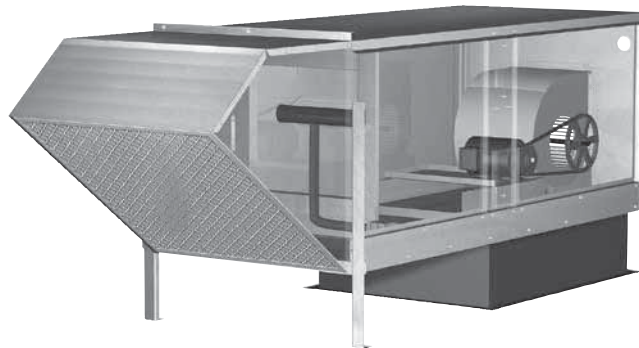

### General Safety Information

Only qualified personnel should install this unit. Personnel should have a clear understanding of these instructions and should be aware of general safety precautions. Improper installation can result in electric shock, possible injury due to coming in contact with moving parts, as well as other potential hazards. Other considerations may be required if high winds or seismic activity are present. If more information is needed, contact a licensed professional engineer before moving forward.

1. Follow all local electrical and safety codes, as well as the National Electrical Code (NEC), the National Fire Protection Agency (NFPA), where applicable. Follow the Canadian Electrical Code (CEC) in Canada
2. The rotation of the wheel is critical. It must be free to rotate without striking or rubbing any stationary objects.
3. Motor must be securely and adequately grounded.
4. Do not spin fan wheel faster than the maximum cataloged fan rpm. Adjustments to fan speed significantly affects motor load. If the fan RPM is changed, the motor current should be checked to make sure it is not exceeding the motor nameplate amps.
5. Do not allow the power cable to kink or come in contact with oil, grease, hot surfaces, or chemicals. Replace cord immediately if damaged.
6. Verify that the power source is compatible with the equipment.
7. Never open blower access doors while the fan is running.

#### DANGER

Always disconnect power before working on or near a unit. Lock and tag the disconnect switch or breaker to prevent accidental power up.

#### CAUTION

When servicing the unit, motor may be hot enough to cause pain or injury. Allow motor to cool before servicing.

#### FOR YOUR SAFETY

If you smell gas:

1. Open windows.
2. Do not touch electrical switches.
3. Extinguish any open flame.
4. Immediately call your gas supplier.

#### FOR YOUR SAFETY

The use and storage of gasoline or other flammable vapors and liquids in open containers in the vicinity of this appliance is hazardous.

#### WARNING

Improper installation, adjustment, alteration, service or maintenance can cause property damage, injury or death. Read the installation, operating and maintenance instructions thoroughly before installing or servicing this equipment.

## Receiving

Upon receiving the product check to make sure all items are accounted for by referencing the bill of lading to ensure all items were received. Inspect each crate for shipping damage before accepting delivery. Notify the carrier if any damage is noticed. The carrier will make notification on the delivery receipt acknowledging any damage to the product. All damage should be noted on all the copies of the bill of lading which is countersigned by the delivering carrier. A Carrier Inspection Report should be filled out by the carrier upon arrival and reported to the Traffic Department. If damaged upon arrival, file claim with carrier. Any physical damage to the unit after acceptance is not the responsibility of manufacturer.

## Unpacking

Verify that all required parts and the correct quantity of each item have been received. If any items are missing, report shortages to your local representative to arrange for obtaining missing parts. Sometimes it is not possible that all items for the unit be shipped together due to availability of transportation and truck space. Confirmation of shipment(s) must be limited to only items on the bill of lading.

## Handling

Units are to be rigged and moved by the lifting brackets provided or by the skid when a forklift is used. Location of brackets varies by model and size. Handle in such a manner as to keep from scratching or chipping the coating. Damaged finish may reduce ability of unit to resist corrosion.

## Storage

Units are protected against damage during shipment. If the unit cannot be installed and operated immediately, precautions need to be taken to prevent deterioration of the unit during storage. The user assumes responsibility of the unit and accessories while in storage. The manufacturer will not be responsible for damage during storage. These suggestions are provided solely as a convenience to the user.

### INDOOR

The ideal environment for the storage of units and accessories is indoors, above grade, in a low humidity atmosphere which is sealed to prevent the entry of blowing dust, rain, or snow. Temperatures should be evenly maintained between 30°F (-1°C) and 110°F (43°C) (wide temperature swings may cause condensation and “sweating” of metal parts). All accessories must be stored indoors in a clean, dry atmosphere.

Remove any accumulations of dirt, water, ice, or snow and wipe dry before moving to indoor storage. To avoid “sweating” of metal parts allow cold parts to reach room temperature. To dry parts and packages use a portable electric heater to get rid of any moisture build up. Leave coverings loose to permit air circulation and to allow for periodic inspection.

The unit should be stored at least 3½ inches (89 mm) off the floor on wooden blocks covered with moisture proof paper or polyethylene sheathing. Aisles between parts and along all walls should be provided to permit air circulation and space for inspection.

### OUTDOOR

Units designed for outdoor applications may be stored outdoors, if absolutely necessary. Roads or aisles for portable cranes and hauling equipment are needed.

The fan should be placed on a level surface to prevent water from leaking into the unit. The unit should be elevated on an adequate number of wooden blocks so that it is above water and snow levels and has enough blocking to prevent it from settling into soft ground. Locate parts far enough apart to permit air circulation, sunlight, and space for periodic inspection. To minimize water accumulation, place all unit parts on blocking supports so that rain water will run off.

Do not cover parts with plastic film or tarps as these cause condensation of moisture from the air passing through heating and cooling cycles.

### Inspection and Maintenance during Storage

While in storage, inspect fans once per month. Keep a record of inspection and maintenance performed.

If moisture or dirt accumulations are found on parts, the source should be located and eliminated. At each inspection, rotate the fan wheel by hand ten to fifteen revolutions to distribute lubricant on motor. Every three months, the fan motor should be energized. If paint deterioration begins, consideration should be given to touch-up or repainting. Fans with special coatings may require special techniques for touch-up or repair.

Machined parts coated with rust preventive should be restored to good condition promptly if signs of rust occur. Immediately remove the original rust preventive coating with petroleum solvent and clean with lint-free cloths. Polish any remaining rust from surface with crocus cloth or fine emery paper and oil. Do not destroy the continuity of the surfaces. Wipe thoroughly clean with Tectyl® 506 (Ashland Inc.) or the equivalent. For hard to reach internal surfaces or for occasional use, consider using Tectyl® 511M Rust Preventive or WD-40® or the equivalent.



## REMOVING FROM STORAGE

As units are removed from storage to be installed in their final location, they should be protected and maintained in a similar fashion, until the equipment goes into operation.

Prior to installing the unit and system components, inspect the unit assembly to make sure it is in working order.

1. Check all fasteners, set screws on the fan, wheel, bearings, drive, motor base, and accessories for tightness.
2. Rotate the fan wheel(s) by hand and assure no parts are rubbing.

## Table of Contents

### Installation

Clearance to Combustibles/Service Clearances . . .	3
Unit Arrangement DB / HZ. . . . .	4
Hinged Weatherhood - XDGK-H25 . . . . .	5
Electrical Wiring . . . . .	5
Direct Gas Piping . . . . .	6

### Start-Up

Start-Up Checklist . . . . .	6-7
Blower . . . . .	8
Direct Gas . . . . .	9-11

### Troubleshooting

Blower . . . . .	12
Heater, General . . . . .	12
Heater XDGK-H15 . . . . .	13
Heater XDGK-H25 . . . . .	14-15
Excessive Noise or Vibration . . . . .	16

### Maintenance

Routine . . . . .	17
Fall . . . . .	17

### Reference

Gas Train Layout XDGK-H15 - <400 MBH . . . . .	18
Control Center Layout XDGK-H15. . . . .	18
Gas Train Layout XDGK-H25 - <800 MBH . . . . .	19
Control Center Layout XDGK-H25. . . . .	19
Our Commitment . . . . .	Backcover

## Clearance to Combustibles

	Floor	Top	Sides	Ends
<b>Insulated Units</b>	0 inches	0 inches	0 inches	0 inches

Clearance to combustibles is defined as the minimum distance required between the heater and adjacent combustible surfaces to ensure the adjacent surface's temperature does not exceed 90° above the ambient temperature.

## Service Clearances

Recommended Minimum Service Clearances	
<b>Housing 32 and less</b>	42 inches on the controls side of the unit

Clearances for component removal may be greater than the service clearances listed.



# Installation of Arrangement DB / HZ

**1. Install Curb or Equipment Support(s):** Position curb/equipment support(s) on the roof. (Reference the CAPS submittal for placement of curb/equipment support(s) in relation to the unit). Verify that unit supports are level, shim if necessary. Attach curb to roof and flash into place. Attach the equipment support(s) to the roof, remove metal cover, flash to wooden nailer and reinstall cover. Refer to roof curb detail.

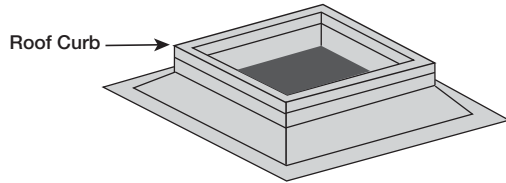

**NOTE**  
The use of a duct adapter is recommended on a downblast (DB) arrangement to align the ductwork with the supply unit. The duct adapter is only a guide and is not to be used as a support for the ductwork.

**2. Install Ductwork:** Good duct practices should be followed for all ductwork. All ductwork should be installed in accordance with SMACNA and AMCA guidelines, NFPA 96 and all local codes.

Model	Supply Duct Size (A x B)	Distance from right side of Curb to Center Supply Duct (C)	Curb Dimension Actual (D x E)
XDGK-109-H15	13 x 14	14½	27½ x 27½
XDGK-110-H15	14 x 16		
XDGK-112-H15	16 x 18		
XDGK-115-H25	18 x 22	20	45½ x 45½
XDGK-118-H25	22 x 24		

All dimensions shown are in inches.

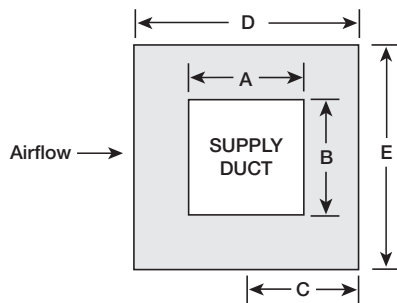

**Roof Opening Details**

Note: Roof opening requirements:

**Minimum roof opening:** the minimum roof opening size is the duct diameter plus 0.25 inches on all sides. For example, if the duct were 14 x 14 inches square, then the minimum roof opening size is 14.5 x 14.5 inches square.

**Maximum roof opening:** there must be a minimum perimeter of 1.75 inches between the roof and the roof curb. For example, if the roof curb is 75 x 30 inches square, the maximum roof opening is 71.5 x 26.5 inches square.

**3. Apply Sealant:** Apply an appropriate sealant around the perimeter of the curb to isolate fan vibration and prevent water penetration.

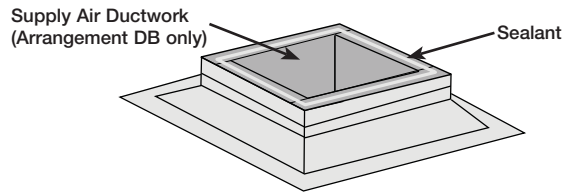

**NOTE**  
The use of all lifting brackets and a set of spreader bars is mandatory when lifting unit.

**4. Install Unit:** Use a crane and a set of spreader bars hooked to the factory lifting lugs to lift and center the unit on the curb/equipment support(s).

Use self-tapping sheet metal screws to fasten the unit to the curb/equipment support(s).

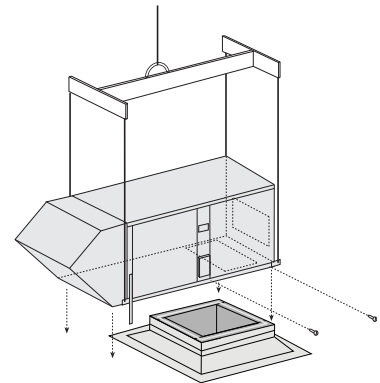

## Installation of Hinged Weatherhood

### TOOLS REQUIRED

- 5/16-inch nut runner
- Caulk gun with weatherproof sealant

The XDGK-H25 weatherhood is folded-up and shipped on top of the unit:

To install:

1. Rotate one side up on weatherhood.
  - a. Run two sheet metal screws where shown to hold side in rotated position. Pilot holes are provided.
  - b. Rotate opposite side up on weatherhood and repeat step 1A.
2. Rotate assembly forward.
3. Screw the sides of the weatherhood to the unit. Pilot holes are provided.
4. Caulk all seams with an appropriate weatherproof sealant.
5. Install the two center filter tracks which were shipped inside the unit.
  - a. Slide the tabbed end of each track into the slot at the bottom of the intake opening on the unit housing.
  - b. Rotate the tracks up to the top outer edge of the weatherhood such that the weatherhood edge slides into the slot in the tracks.

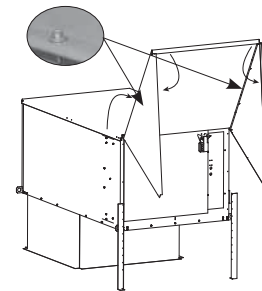
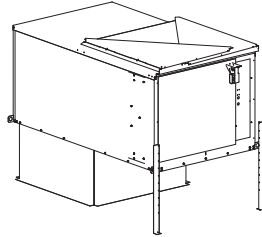

Rotate sides up, install screws. Rotate Assembly forward. See Step 3.

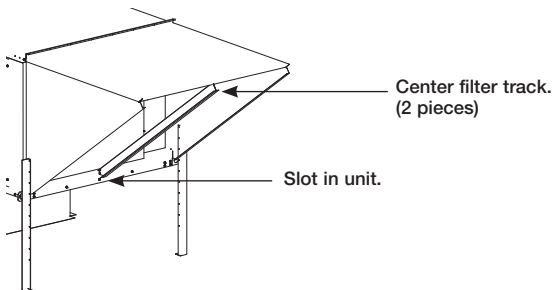

6. Insert the factory provided aluminum mesh intake filter(s) into the track located in the face of the weatherhood. Filters slide in from the top. Be sure the filters are properly orientated (an airflow direction arrow is located on the side of the filters). Insert the retaining screws on the sides of the weatherhood, three (3) per side, to keep the filters in place.

## Installation of Electrical Wiring

### IMPORTANT

Before connecting power to the unit, read and understand the following instructions and the wiring diagrams. Complete wiring diagrams are attached to the inside of the control center door(s).

All wiring should be done in accordance with the latest edition of the National Electrical Code ANSI/NFPA 70 and any local codes that may apply. In Canada, wiring should be done in accordance with the Canadian Electrical Code.

The equipment must be properly grounded. Any wiring running through the unit in the airstream must be protected by metal conduit, metal clad cable or raceways.

### CAUTION

If any of the original wire must be replaced, the replacement wire must have a temperature rating of at least 105°C, except for energy cut-off or sensor lead wire which must be rated to 150°C.

Any wiring deviations may result in personal injury or property damage. Manufacturer is not responsible for any damage to or failure of the unit caused by incorrect final wiring.

### DANGER

High voltage electrical input is needed for this equipment. This work should be performed by a qualified electrician.

1. **Determine the Size of the Main Power Lines:** The unit nameplate states the unit's voltage and total MCA. The main power lines to the unit should be sized accordingly. The nameplate is located on the outside of the unit on the control panel side.

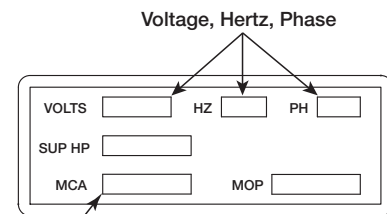

Unit's Total MCA

### Electrical Nameplate

2. **Provide the Opening(s) for the Electrical Connections:** Electrical openings vary by unit size and arrangement and are field-supplied.
3. **Connect the Main Power:** Connect the main power lines to the disconnect switch and main grounding lug(s). Torque field connections to 20 in.-lbs. See the control center layouts in the Reference section for main disconnect and ground lug(s) locations.





# Installation of Direct Gas Piping

## IMPORTANT

All gas piping must be installed in accordance with the latest edition of the National Fuel Gas Code ANSI/Z223.1 and any local codes that may apply. In Canada, the equipment shall be installed in accordance with the Installation Code for Gas Burning Appliances and Equipment (CGA B149) and Provincial Regulations for the class. Authorities having jurisdiction should be consulted before installations are made.

## WARNING

All components of this or any other gas-fired heating unit must be leak tested prior to placing the unit into operation. A soap and water solution should be used to perform this test. NEVER test for gas leaks with an open flame.

## WARNING

When leak testing pressures that are equal to 14 in. wc (3.5 kPa), first close the field-installed shutoff valve to isolate the unit from the gas supply line.

## WARNING

When leak testing pressures that are above 14 in. wc (3.5 kPa), close the field-installed shutoff valve, disconnect the furnace and gas train from the gas supply line and plug the supply line before testing.

## IMPORTANT

All piping should be clean and free of any foreign matter. Foreign material entering the gas train can damage the valves, regulators and burner.

## IMPORTANT

Do NOT connect the unit to gas types other than what is specified and do NOT connect the unit to gas pressures that are outside of the pressure range shown on the label.

## NOTE

When connecting the gas supply, the length of the run must be considered in determining the pipe size to avoid excessive pressure drop. Refer to a Gas Engineer's Handbook for gas pipe capacities.

## 1. Determine the Supply Gas Requirements

The unit's direct gas nameplate states the requirements for the gas being supplied to the unit. The direct gas nameplate is located on the outside of the unit on the control center side.

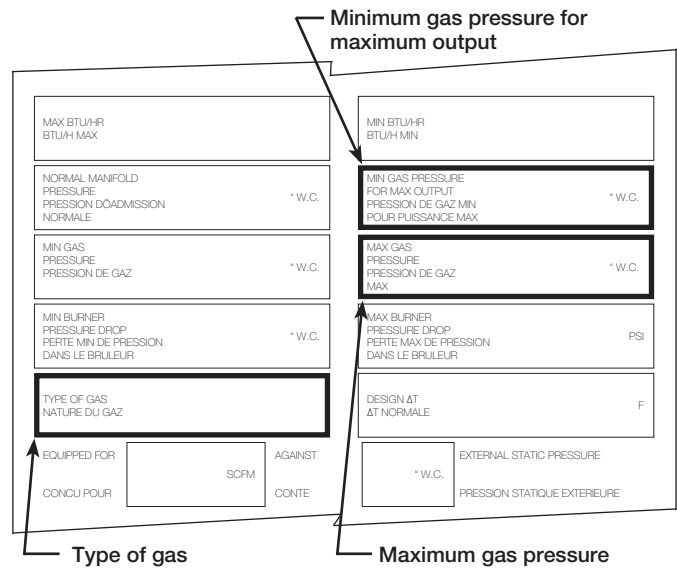

Direct Gas Nameplate

## 2. Install Additional Regulator if Required

When the supply gas pressure exceeds the maximum gas pressure shown on the direct gas nameplate, an additional regulator (by others) is required to reduce the pressure. The regulator must have a listed leak limiting device or it must be vented to the outdoors.

## NOTE

The regulator located inside the unit is used to adjust the unit's maximum output temperature.

## 3. Connect the Supply Gas Line

A manual shut off valve (gas cock), 1/8 in. plugged test port and 6 in. drip leg must be installed prior to the gas train. The valve and the test port must be accessible for the connection of a test gauge. Supply gas connections must be made by a qualified installer and are not furnished by manufacturer.

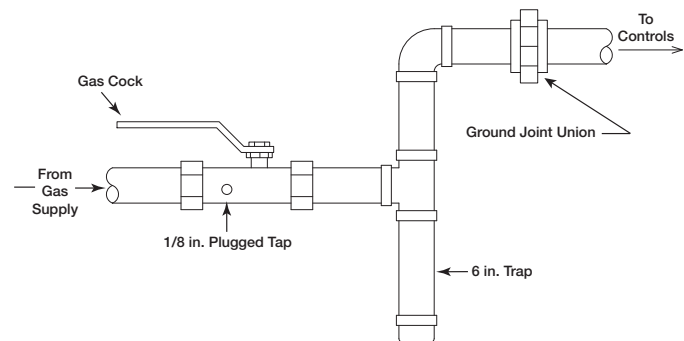

Supply Gas Line



## Installation of Direct Gas Piping, *continued*

### 4. Pipe the Optional Vent Line

If an optional vent line is located between the safety shutoff valves, it must be piped to the outdoors.

#### WARNING

Reference the National Fuel Gas Code for additional vent line requirements.

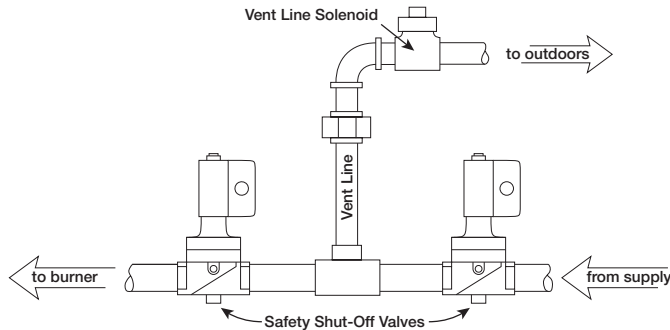

Optional Vent Line

### 5. Test the System for Leaks

Check both the supply lines and the factory piping for leaks. Apply a soap and water solution or other approved leak test solution to all piping and watch for bubbling which indicates a leak.

#### WARNING

NEVER test for a gas leak with an open flame.

#### NOTE

The factory piping has been checked for leaks, but should be rechecked due to shipping and installation.

## Start-Up – Checklist

Unit Model Number \_\_\_\_\_

(e.g. XDGK-109-H15)

Unit Serial Number \_\_\_\_\_

(e.g. 04C99999 or 10111000)

Start-Up Date \_\_\_\_\_

Start-Up Personnel Name \_\_\_\_\_

Start-Up Company \_\_\_\_\_

Phone Number \_\_\_\_\_

**Pre Start-Up Checklist** – check boxes as items are completed.

- Disconnect and lock-out all power switches
- Check tightness of all factory wiring connections
- Check all fasteners, set-screws, and locking collars on the fans, bearings, motor bases and accessories for tightness
- Check fan belt drives for proper alignment and tension
- Hand-rotate blower to verify free rotation
- Remove any shipping fasteners from the blower vibration isolators
- Verify supply voltage to the main disconnect
- Verify the supply gas pressure

**Start-Up Blower Checklist** – refer to Blower Start-Up section for further detail.

- Check line voltage L1-L2 \_\_\_\_\_
- L2-L3 \_\_\_\_\_
- L1-L3 \_\_\_\_\_
- Check blower rotation
- Check for vibration
- Supply fan RPM \_\_\_\_\_ RPM
- Motor nameplate amps \_\_\_\_\_ Amps
- Actual motor amps \_\_\_\_\_ Amps
- Actual CFM delivered \_\_\_\_\_ CFM

### Component

- Heating inlet air sensor  
 \_\_\_\_\_ Actual Setting  
 - Typical setting 55°-65°F

**Start-Up Direct Gas** – refer to Direct Gas Start-Up for further detail.

- Check supply gas pressure  
 \_\_\_\_\_ Maximum  
 \_\_\_\_\_ Minimum  
 \_\_\_\_\_ Actual
- Set burner pressure differential  
 \_\_\_\_\_ Actual Setting  
 - Typical 0.65 in. wg
- Set pilot gas pressure (XDGK H25 only)  
 \_\_\_\_\_ Actual Setting  
 - Pilot gas pressure is 3 in. wg
- Set the maximum firing rate  
 \_\_\_\_\_ temp rise
- Set the minimum firing rate  
 \_\_\_\_\_ check
- Set the unit's operating temperature  
 \_\_\_\_\_ °F



## Start-Up – Blower

### WARNING

Disconnect and lock-out all power before performing any maintenance or service to the unit. Failure to do so could result in property damage and serious injury or death.

### WARNING

Check the housing, blower, weatherhood and ductwork for foreign objects and debris before the blower is energized.

### SPECIAL TOOLS REQUIRED

- Voltage meter (with wire probes)
- Amperage meter
- Micro amp meter
- Tachometer
- Thermometer
- Incline manometer or equivalent

- 1. Check the Voltage:** Before starting the unit, compare the supplied voltage, hertz, and phase with the unit and motor nameplate information. The nameplate is located on the outside of the unit on the control panel side.

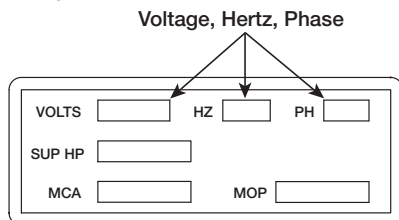

**Electrical Nameplate**

- 2. Check the Blower Rotation:** Open the blower access door and run the blower momentarily to determine the rotation. Arrows are placed on the blower scroll to indicate the proper direction.

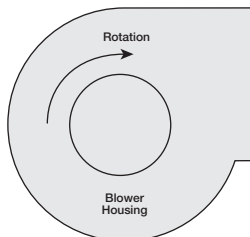

**Blower Rotation**

### IMPORTANT

If the blower is rotating in the wrong direction, the unit will move some air, but will not perform as designed. Be sure to perform a visual inspection to guarantee the correct blower rotation.

### TO REVERSE ROTATION

To reverse the rotation, disconnect and lock-out the power.

**Single Phase:** Rewire the motor per the manufacturer's instructions.

**Three Phase:** Interchange any two power leads.

- 3. Check for Vibration:** Check for unusual noise, vibration or overheating of the bearings. Reference the Troubleshooting section for corrective actions.

Excessive vibration may be experienced during the initial start-up. Left unchecked, it can cause a multitude of problems including structural and/or component failure.

Generally, fan vibration and noise is transmitted to other parts of the building by the ductwork. To minimize this undesirable effect, the use of heavy canvas duct connectors is recommended.

### WARNING

Changing the air volume can significantly increase the amp draw of the motor. If the air volume is changed, the motor's amps must be checked to prevent overloading the motor.

- 4. Motor Check:** Measure the motor's voltage, amps and RPM's and compare to the specifications on the motor's nameplate. Check the overload setting and make sure it matches the motor's amperage rating. If the motor's actual amps are greater than the nameplate amps, check and correct the supply voltage or air volume of the blower.
- 5. Air Volume Measurement and Check:** Measure the unit's air volume (CFM) and compare it with its rated air volume. If the air volume is off, adjust the fan's RPM's by changing/adjusting the drive.

The most accurate way to measure the air volume is by using a pitot traverse method downstream of the blower. Other methods can be used, but should be proven and accurate.

To ensure accuracy, be sure the dampers are open when checking the air volume.

- 6. Set-Up Heating Inlet Air Sensor:** The heating inlet air sensor will automatically turn the heat on if the outdoor air temperature is below the set point while the fan is operating.

- Typical setting: 55°-65°F





# Start-Up – Direct Gas

**IMPORTANT**

For proper unit function and safety, follow the start-up procedure in the exact order that it is presented.

**IMPORTANT**

This start-up should begin after all of the installation and the Blower Start-Up procedures have been completed.

**1. Check the Supply Gas Pressure:** Check the supply gas pressure and compare it with the unit's nameplate pressure requirements. Adjust the supply regulator as needed until the supply gas pressure is within the specified range. The nameplate is located on the outside of the unit on the control panel side.

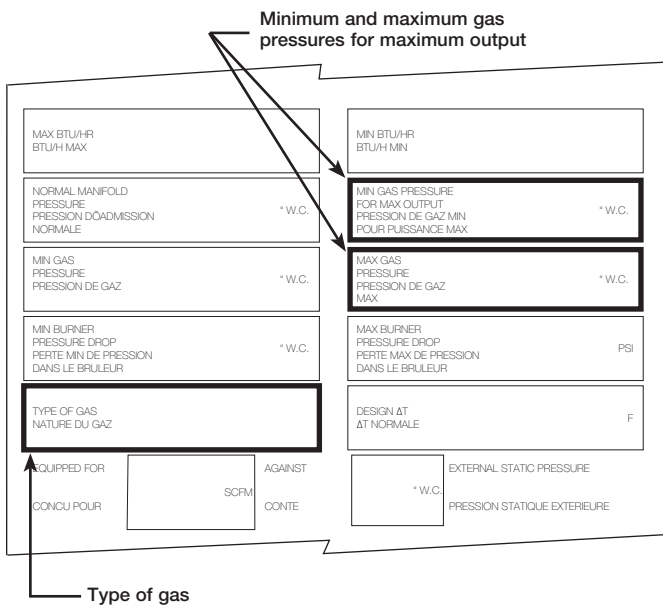

**Direct Gas Nameplate**

**IMPORTANT**

Proper air velocity over the burner is critical on direct fired gas units. If the air velocity is not within the unit specifications, the unit will not operate efficiently, may have sporadic shutdowns and may produce excessive carbon monoxide (CO) or other gases.

**2. Set the Burner Air Pressure Differential:** With all filters, the blower access door in place, and the fan running and discharging 70°F air, connect a U-Tube manometer to the airflow taps (inside the unit control center) and measure the static pressure across the burner.

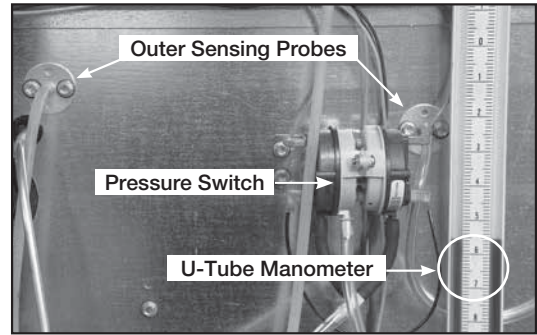

**Measuring the Pressure Drop**

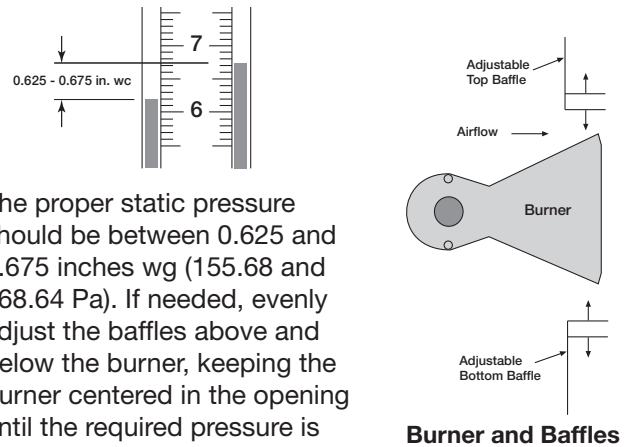

The proper static pressure should be between 0.625 and 0.675 inches wg (155.68 and 168.64 Pa). If needed, evenly adjust the baffles above and below the burner, keeping the burner centered in the opening until the required pressure is obtained.

**Burner and Baffles**

**NOTE**

The pressure drop was set at the factory and may not need adjustment.

**NOTE**

When required pressure is obtained, be sure to reconnect the outer sensing probes.

**IMPORTANT**

This process may need to be repeated until the proper pressure is achieved. This adjustment will change the air quantity delivered by the unit and therefore the air quantity delivered should be rechecked. Refer to the Blower Start-Up section.

**NOTE**

To increase the static pressure, decrease the opening. To decrease the static pressure, increase the opening.

**3. FOR XDGK-H25 ONLY:** Check the pilot gas pressure. The recommended gas pressure is 3 in. wg.

Adjust the pilot gas regulator as needed. The location of the pilot regulator adjustment is shown on the pilot valve/regulator image below.

Pilot Regulator adjustment screw

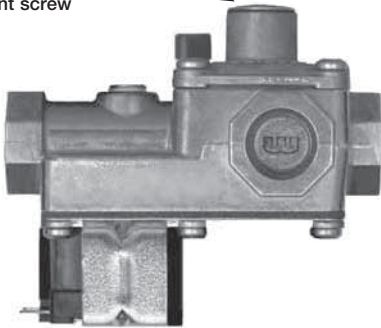

**XDGK-H25 Pilot Valve/Regulator**

Rotate the adjustment screw CW to increase the pilot flame and rotate the screw CCW to decrease the pilot flame.

**4. Set the Low Fire Time Delay:** Set the low fire time delay to 75% of its maximum setting. See Maxitrol Series 14 (pictured below) for the location of the time delay setting.

The low fire time delay must be set high enough to provide at least 15 seconds of low fire while the unit tries to light.

**5. Set the Maximum Firing Rate:** Monitor the unit's actual temperature rise by placing a thermocouple in the unit's inlet and a second in the discharge, three duct diameters downstream of the burner.

Send the unit to maximum fire by disconnecting and isolating the wire connected to Terminal 4 on the Maxitrol amplifier shown.

While monitoring the unit's temperature rise, set the maximum firing rate by adjusting the Combination Valve or Regulator for respective housing sizes (shown to right) until the designed temperature rise is achieved. After setting the maximum firing rate, reconnect the wire to the amplifier.

**NOTE**

Do not set the burner maximum firing rate based on gas pressure. It should be set based on the unit's designed temperature rise shown on the direct gas label.

MAX BTU/HR BTU/H MAX	MIN BTU/HR BTU/H MIN
NORMAL MANIFOLD PRESSURE PRESSION D'ADMISSION NORMALE * W.C.	MIN GAS PRESSURE FOR MAX OUTPUT PRESSION DE GAZ MIN POUR PUISSANCE MAX * W.C.
MIN GAS PRESSURE PRESSION DE GAZ * W.C.	MAX GAS PRESSURE PRESSION DE GAZ MAX * W.C.
MIN BURNER PRESSURE DROP PERTE MIN DE PRESSION DANS LE BRULEUR * W.C.	MAX BURNER PRESSURE DROP PERTE MAX DE PRESSION DANS LE BRULEUR PSI
TYPE OF GAS NATURE DU GAZ	DESIGN AT AT NORMALE F
EQUIPPED FOR CONCU POUR	AGAINST CONTRE
SCRM	* W.C. EXTERNAL STATIC PRESSURE PRESSION STATIQUE EXTERIEURE

**Direct Gas Nameplate**

**IMPORTANT**

Setting the maximum firing rate during mild weather conditions may cause the high limit to trip out during extreme conditions requiring manual resetting.

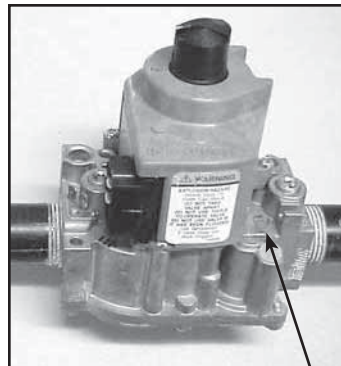

**XDGK-H15  
Combination Valve**

Maximum firing rate adjustment

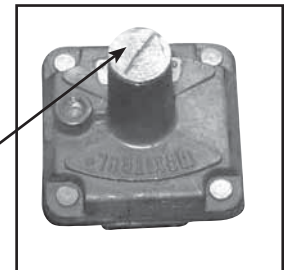

**XDGK-H25 Regulator**

Clockwise rotation increases the temperature rise, counterclockwise rotation decreases the temperature rise.

The minimum setting for the maximum fire rate may be higher than required. This is acceptable. The burner will modulate as needed.



**6. Set the Minimum Firing Rate:** Disconnect and isolate one of the wires running to the modulating valve to send the unit to its minimum firing rate. Set the minimum firing rate by adjusting the needle valve as shown in the image below.

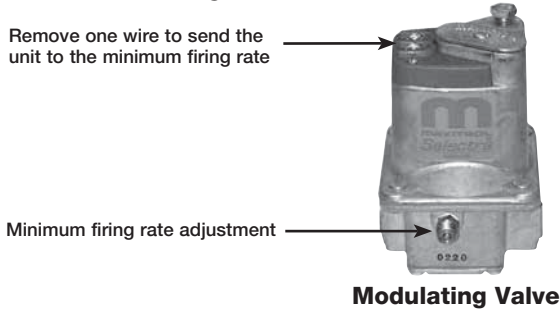

After setting the minimum firing rate, reconnect the wire to the modulating valve.

Adjusting the maximum and minimum fire may require the inlet air sensor to be initially set higher than desired in order to start the burner. Once high and low fire have been set, the inlet air sensor should be turned down to the desired temperature.

<b>IMPORTANT</b>
The minimum firing rate setting is critical. If the setting is too high, the unit may not light, too low and the flame rod may not detect the flame.
<b>IMPORTANT</b>
The proper minimum firing rate setting results in a small ribbon of continuous flame which covers the flame rod and runs across the entire burner.
<b>IMPORTANT</b>
Do not allow the disconnected wire to come in contact with a potential ground, damage to the amplifier or transformer could result.

**7. Set the Unit's Discharge Temperature:** Set the discharge temperature that will provide the desired space temperature.

The Maxitrol Series 14 should be set to the desired discharge temperature. The temperature selector is built into the amplifier.

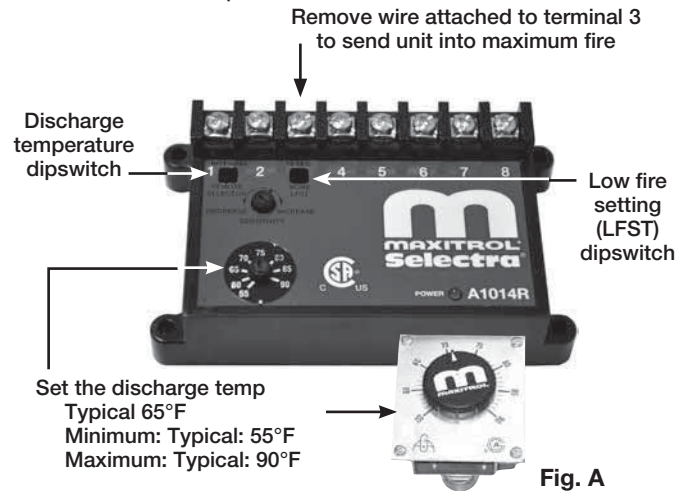

**Maxitrol Series 14 – 8 terminals**

**8. Flame Signal Check:** To measure the flame signal, disconnect the flame sensor wire from Sense terminal on ignition controller. Connect one multimeter lead to the flame sensor wire and one to the Sense terminal (series). Set multimeter range to micro amps. The flame signal should be between .15 to .3 micro amps.

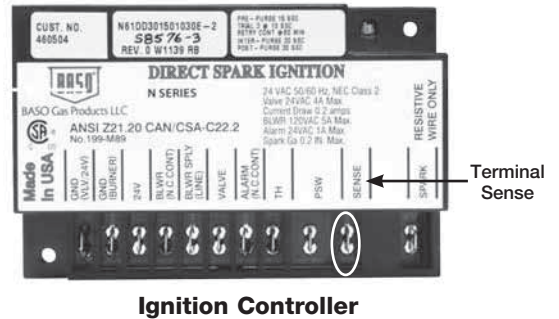

# Troubleshooting

## Blower Does Not Operate

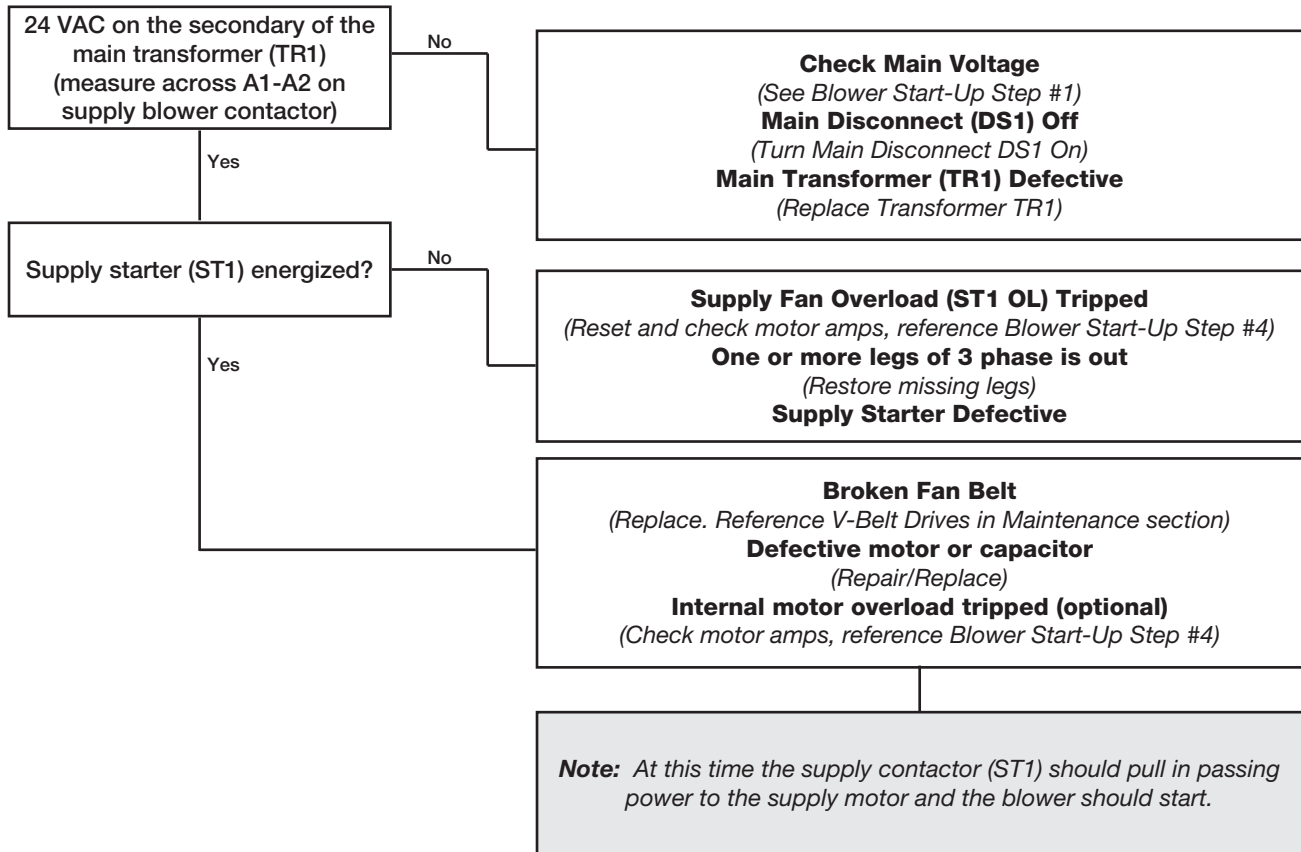

## Heater Does Not Operate

**Does not attempt to light. No visible spark.**

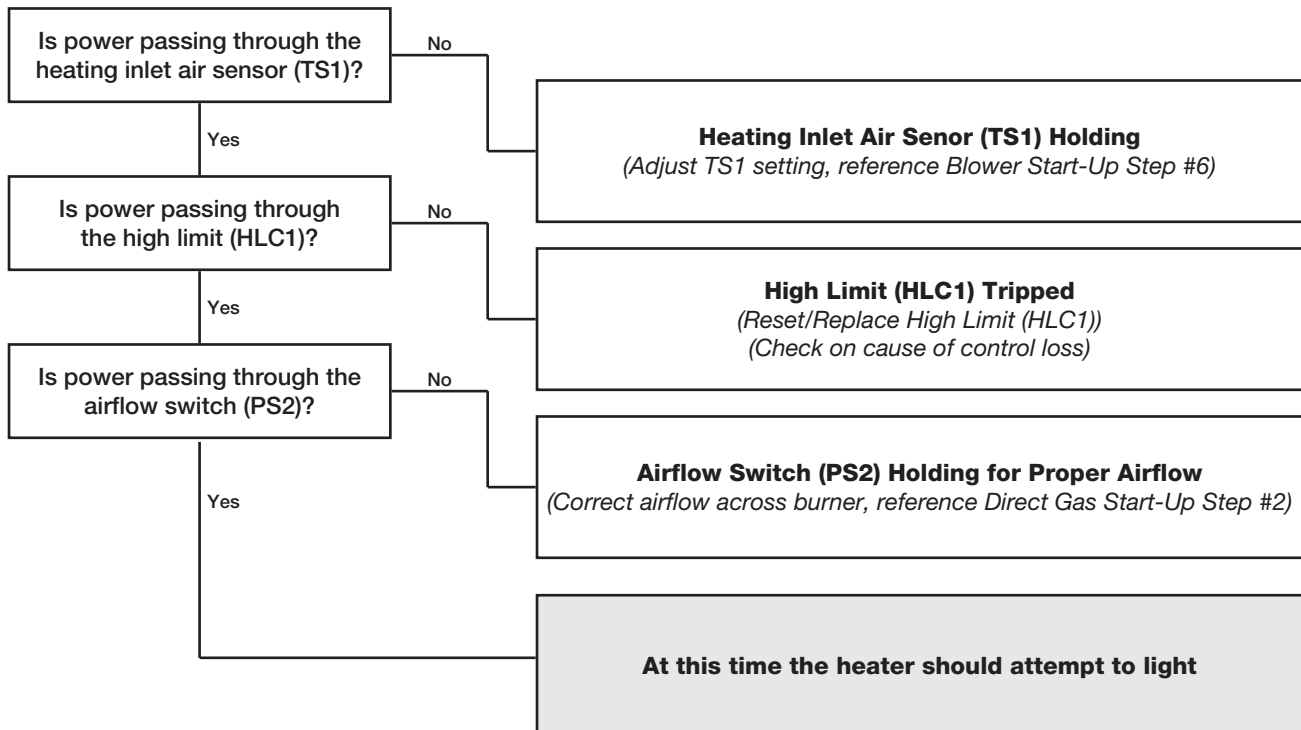

# Troubleshooting

## Heater Does Not Operate – XDGK-H15 Attempts to light but no flame. Visible spark.

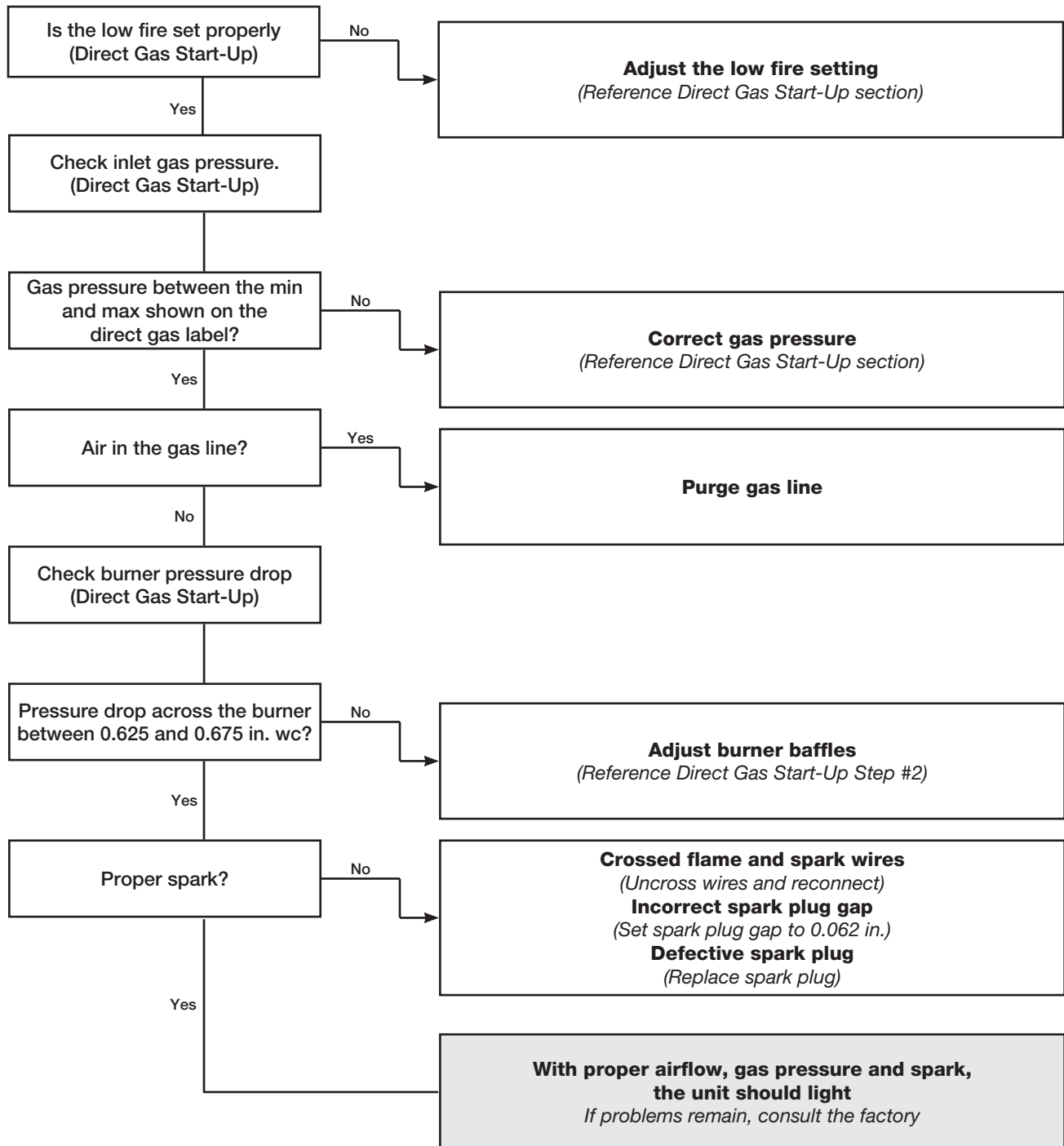



# Troubleshooting

## Heater Does Not Operate – XDGK-H25 Attempts to light but no visible pilot. Visible spark.

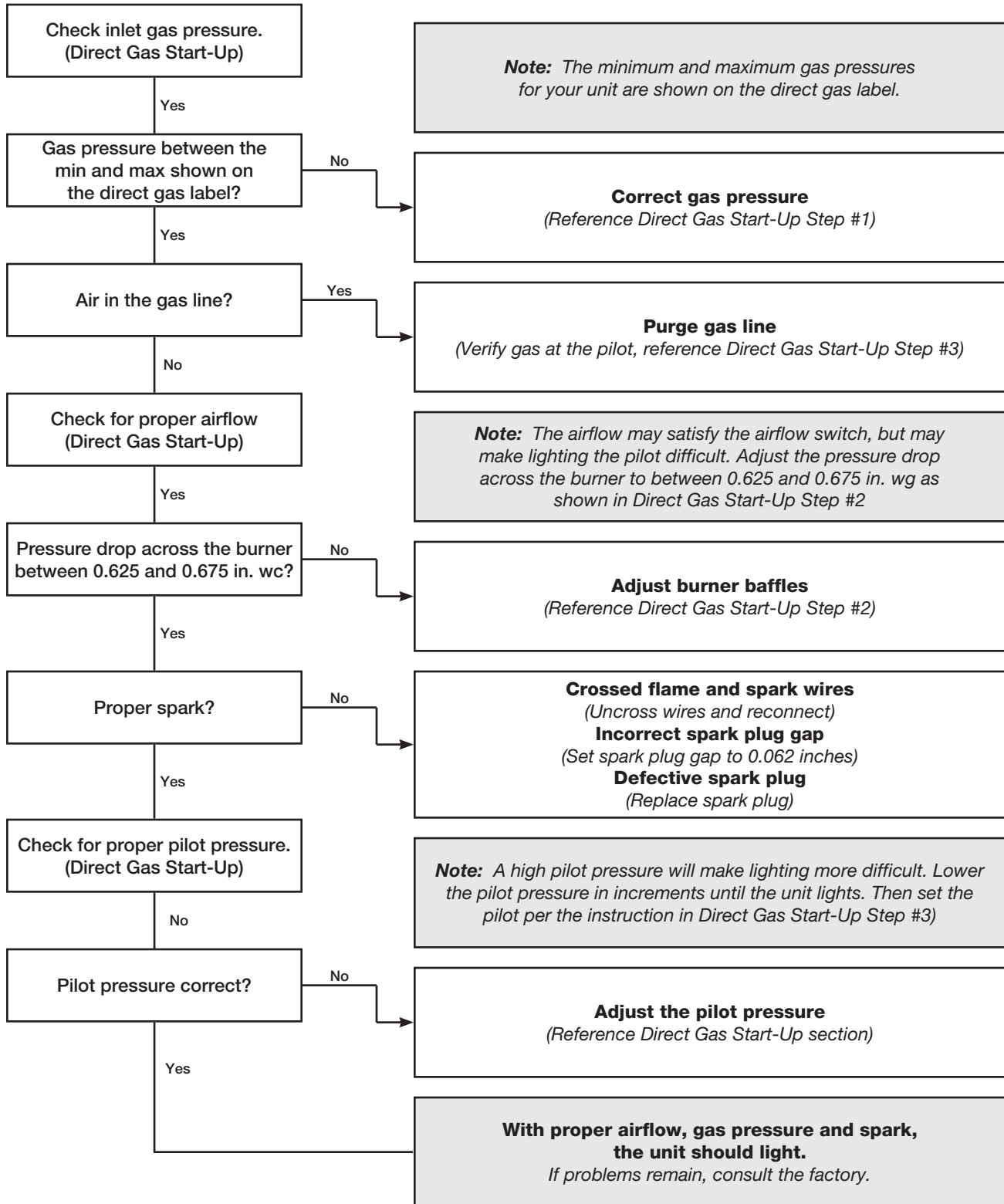

# Troubleshooting

## Heater Does Not Operate – XDGK-H25

Visible pilot.

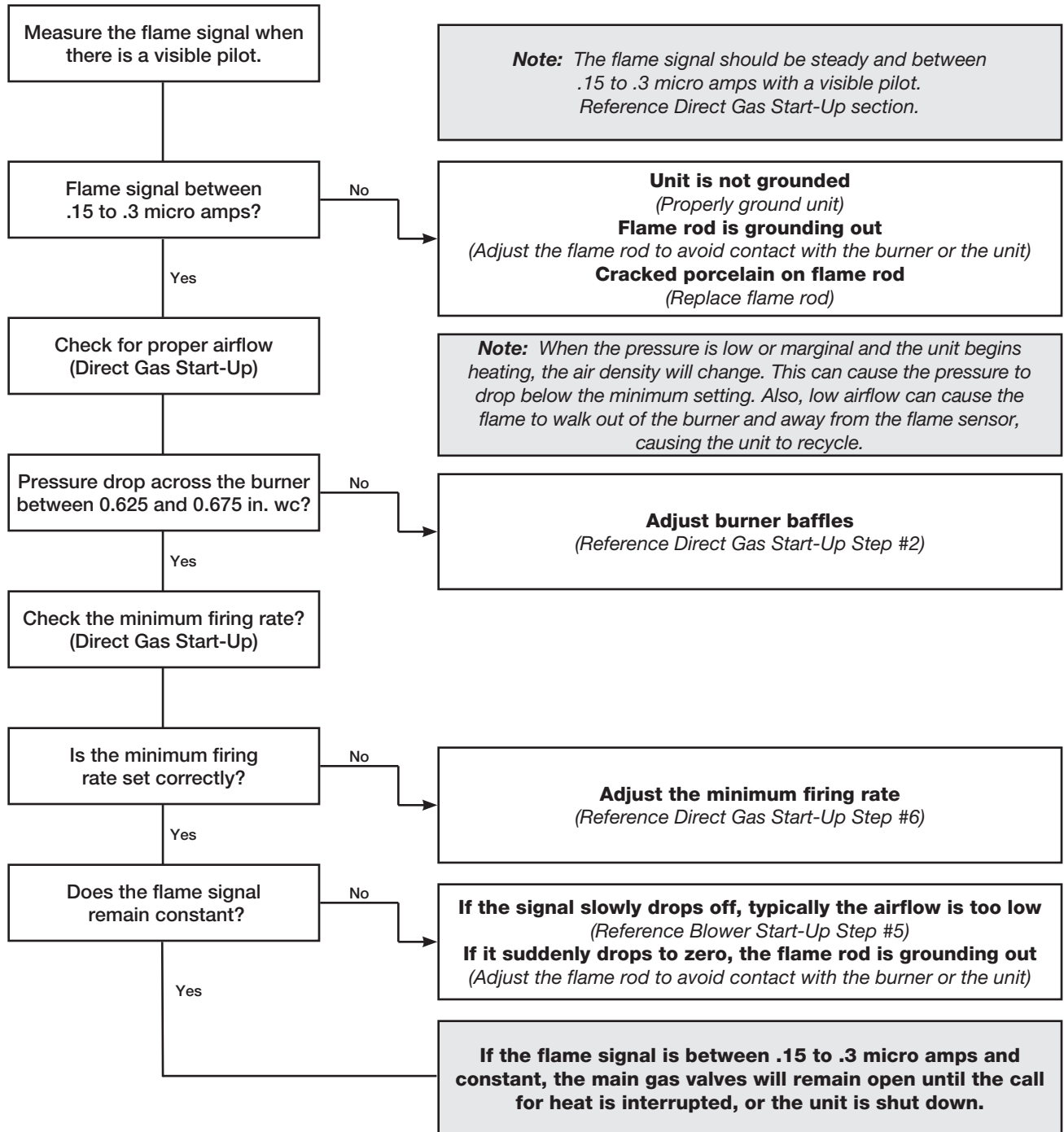

# Troubleshooting

## Excessive Noise or Vibration

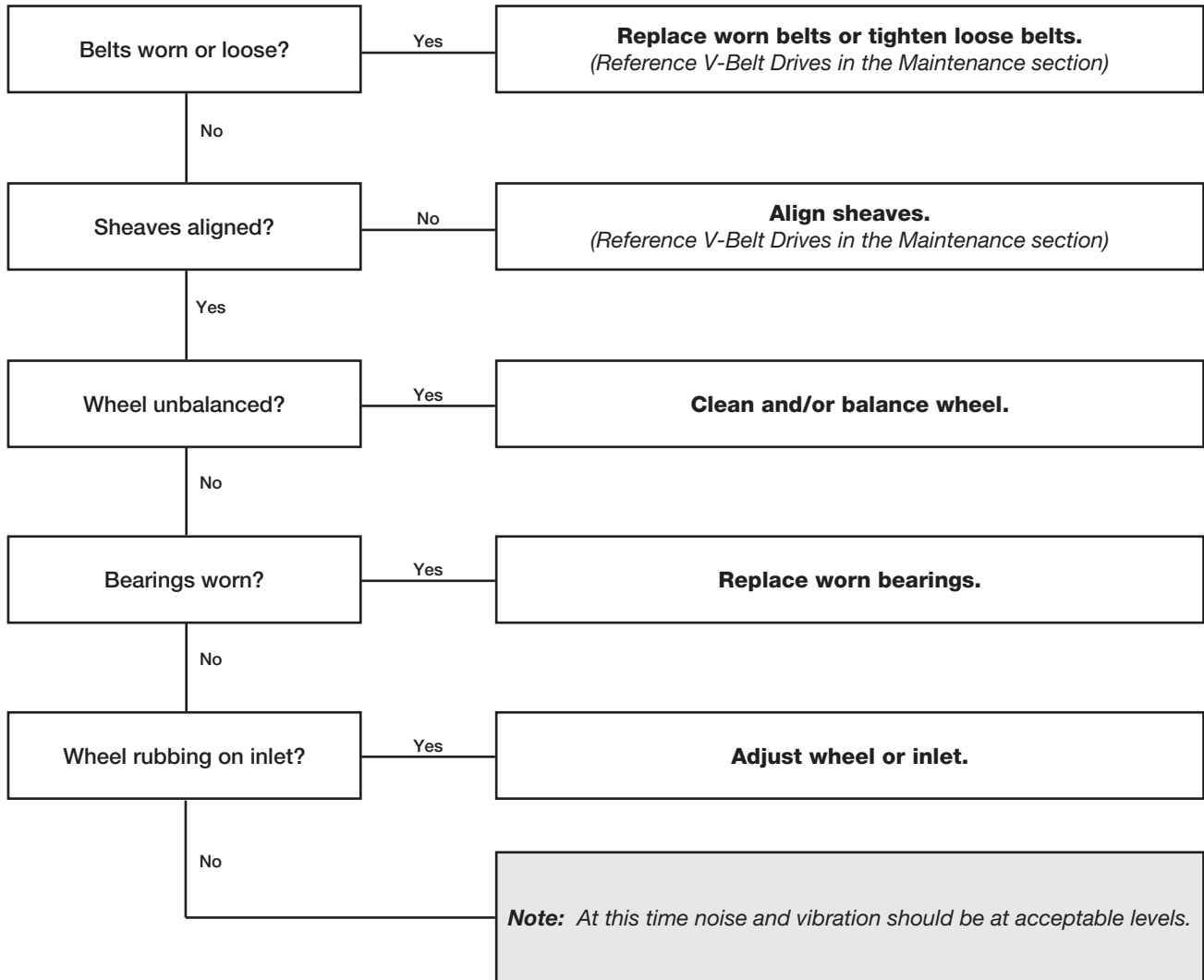

## Maintenance – Routine

### CAUTION

Lock-out the gas and the electrical power to the unit before performing any maintenance or service operations to this unit.

**V-Belt Drives** – V-belt drives must be checked on a regular basis for wear, tension, alignment and dirt accumulation. Check the alignment by using a straight edge across both sheaves as shown. Check the tension by measuring the deflection in the belt as shown.

- Improper belt tension and/or misaligned sheaves

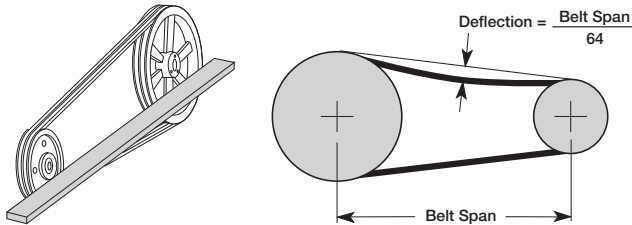

lead to premature and frequent belt failures.

Abnormally high belt tension or drive misalignment will cause excessive bearing loads and may result in failure of fan and/or motor bearings. Abnormally low belt tension will cause squealing on start-up, excessive belt flutter, slippage and overheated sheaves.

- Do not pry belts on or off the sheave. Loosen belt tension until belts can be removed by gently lifting them off of the sheaves.
- When replacing V-belts on multiple groove drives, all belts should be changed to provide uniform drive loading.
- Do not install new belts on worn sheaves. If the sheaves have grooves worn in them, they must be replaced before new belts are installed.

**Motors** – Motor maintenance is generally limited to cleaning and lubrication (where applicable).

Cleaning should be limited to exterior surfaces only. Removing dust and grease build-up on the motor assures proper motor cooling.

Motors supplied with grease fittings should be greased in accordance with the manufacturer's recommendations.

- Greasing of motors is only intended when fittings are provided. Many motors are permanently lubricated and will not require additional lubrication.

### CAUTION

Do not allow water or solvents to enter the motor or bearings. Under no circumstances should motors or bearings be sprayed with steam, water or solvents.

**Wheels** – Wheels require little attention when moving clean air. Occasionally, oil and dust may accumulate on the wheel causing imbalance. When this occurs the wheel and housing should be cleaned to assure proper operation.

**Filters** – Filter maintenance is generally limited to cleaning and replacement. The aluminum mesh filters can be washed in warm soapy water. An adhesive spray can be added to increase the filter efficiency.

- Be sure to reinstall filters with the airflow in the correct direction. An airflow direction arrow is located on the side of the filters.
- Replacement filters should be from the same manufacturer and be the same size as the original filters provided with the unit.

## Maintenance – Fall

**Start-Up** – Repeat the Blower Start-Up procedure #4 and Direct Gas Start-Up procedure #1 and #2. This will ensure that the gas and air are set properly before the heating season begins and should lead to trouble free operation all winter.

**High Limit** – The high limit switch may have tripped over the summer. It should be checked and reset if necessary.

**Burner** – Inspect the burner for accumulation of scales on both the upstream and downstream sides of the mixing plates. Any scaling or foreign material should be removed with a wire brush.

Visually check that all holes in the mixing plates are clear. If any burner ports are plugged—even partially—clear them with a piece of wire or another appropriate tool. **Do not enlarge burner ports when clearing a blockage, performance could be affected.**

Replace or tighten any loose or missing fasteners on the mixing plates. Always use zinc plated or stainless steel fasteners.

Inspect and clean the flame and spark rod. Occasional replacement of the flame rod and spark rod may be necessary to ensure optimum unit performance. Flame rods can last many years, but because of thermal expansion of the porcelain, flame rods can fail over time.

**Gas Train** – The gas connections, joints and valves should be checked annually for tightness. Apply a soap and water solution to all piping; watch for bubbling which indicates a leak. Other leak testing methods can be used.



## Reference

### Typical XDGK-H15 Gas Train Layout – Less than 400 MBH and Control Center Layout

This is a typical gas train. The gas train in your unit may be different.

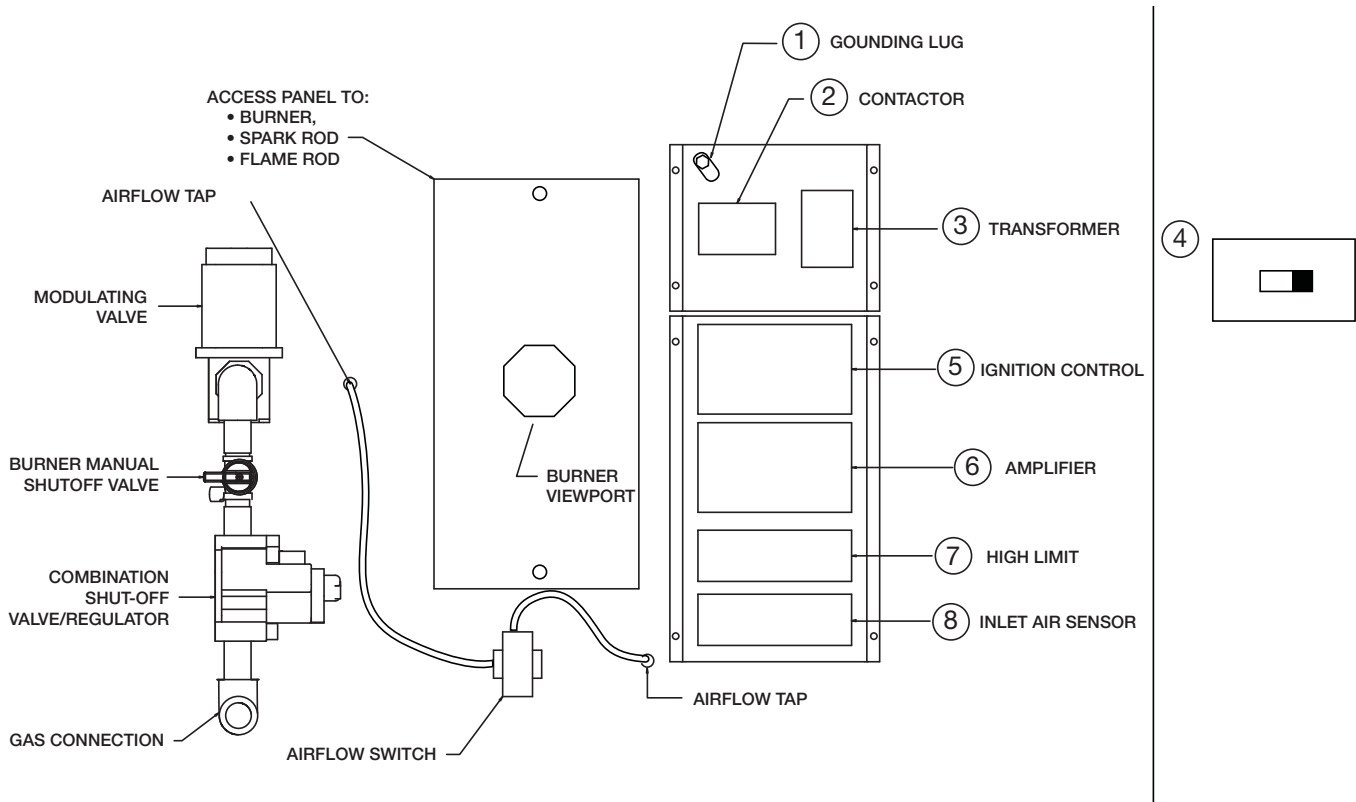

- 1. Grounding Lug** - Completes electrical circuit.
- 2. Motor Starter** - 24 volt magnetic contacts for starting motor, 3 phase motors have electronic overload.
- 3. Control Transformer** - Provides 24 volts for controls.
- 4. Main Disconnect** - On/Off switch, provides single point power connection to unit.
- 5. Ignition Control** - Monitors flame, shuts down unit when unsafe conditions are detected.
- 6. Amplifier** - Controls modulating valve; assures the desired temperature is delivered.
- 7. High Limit** - Prevents unit from discharging air above a set point.
- 8. Heating Inlet Air Sensor** - Ductstat that automatically energizes burner when inlet air temperature falls below set point.





# Reference

## Typical XDGK-H25 Gas Train Layout – Less than 800 MBH

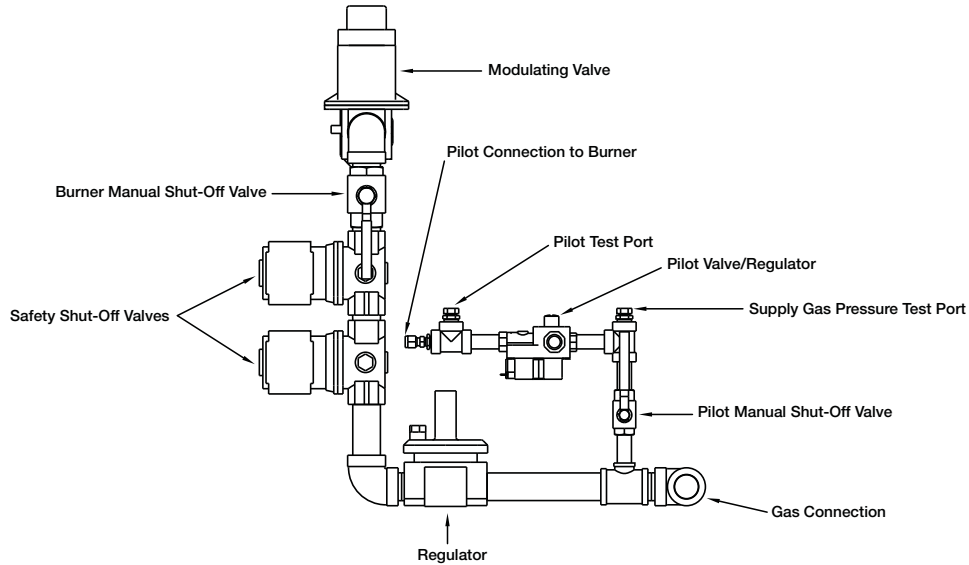

## Typical XDGK-H25 Control Center Layout

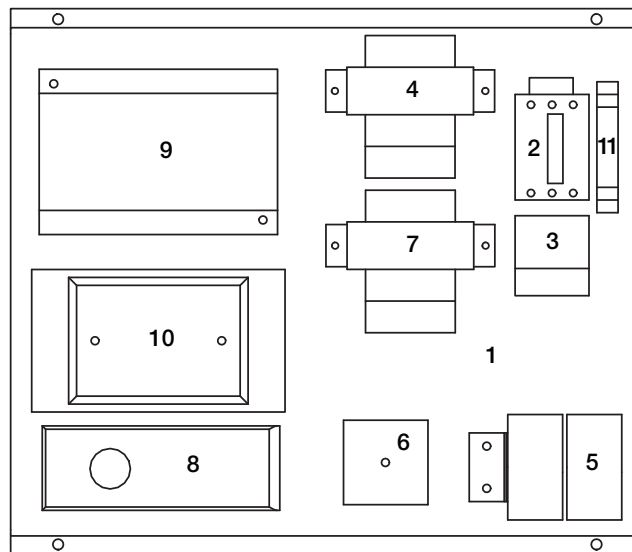

1. **Control Board** - Provides mounting for the controls.
2. **Supply Motor Starter** - 24 volt magnetic contacts for starting supply motor.
3. **Supply Overload** - Provides electronic overload protection to supply motor.
4. **Low Voltage Transformer** - 75 VA transformer that provides low voltage to fan/starter controls and optional inlet damper.
5. **Air Proving Switch** - Monitors the airflow to ensure proper combustion.
6. **Purge Timer** - Initiates 10 second prepurge before lighting the burner.
7. **Low Voltage Transformer** - 75 VA transformer that provides low voltage to the heat controls.
8. **Inlet Air Sensor** - Outdoor air stat that automatically controls the heating based on outdoor air temperature.
9. **Flame Safeguard/Spark Generator** - Monitors flame, shuts down unit when unsafe conditions are detected.
10. **Amplifier** - Controls modulating valve, assures the desired temperature is delivered.
11. **Heat Relay** - Allows amplifier to modulate the modulating gas valve.
12. **High Limit** (not pictured) - Disc shaped component located in the upper right hand corner of the control center. Prevents the unit from discharging air above a fixed set point of 120°F.



# Maintenance Log

---

Date \_\_\_\_\_ Time \_\_\_\_\_ AM/PM

Notes: \_\_\_\_\_  
\_\_\_\_\_  
\_\_\_\_\_  
\_\_\_\_\_

Date \_\_\_\_\_ Time \_\_\_\_\_ AM/PM

Notes: \_\_\_\_\_  
\_\_\_\_\_  
\_\_\_\_\_  
\_\_\_\_\_

Date \_\_\_\_\_ Time \_\_\_\_\_ AM/PM

Notes: \_\_\_\_\_  
\_\_\_\_\_  
\_\_\_\_\_  
\_\_\_\_\_

Date \_\_\_\_\_ Time \_\_\_\_\_ AM/PM

Notes: \_\_\_\_\_  
\_\_\_\_\_  
\_\_\_\_\_  
\_\_\_\_\_

Date \_\_\_\_\_ Time \_\_\_\_\_ AM/PM

Notes: \_\_\_\_\_  
\_\_\_\_\_  
\_\_\_\_\_  
\_\_\_\_\_

Date \_\_\_\_\_ Time \_\_\_\_\_ AM/PM

Notes: \_\_\_\_\_  
\_\_\_\_\_  
\_\_\_\_\_  
\_\_\_\_\_

Date \_\_\_\_\_ Time \_\_\_\_\_ AM/PM

Notes: \_\_\_\_\_  
\_\_\_\_\_  
\_\_\_\_\_  
\_\_\_\_\_

Date \_\_\_\_\_ Time \_\_\_\_\_ AM/PM

Notes: \_\_\_\_\_  
\_\_\_\_\_  
\_\_\_\_\_  
\_\_\_\_\_

## Our Commitment

---

*As a result of our commitment to continuous improvement, Accurex reserves the right to change specifications without notice.*

Specific Accurex product warranties are located on [accurex.com](http://accurex.com) within the product area tabs and in the Library under Warranties.



P.O. Box 410 Schofield, WI 54476  
Phone: 800.333.1400 • Fax: 715.241.6191  
Parts: 800.355.5354 • [www.accurex.com](http://www.accurex.com)