

Installation, Operation and Maintenance Manual

Please read and save these instructions for future reference. Read carefully before attempting to assemble, install, operate or maintain the product described. Protect yourself and others by observing all safety information. Failure to comply with these instructions will result in voiding of the product warranty and may result in personal injury and/or property damage.



General Safety Information

Only qualified personnel should install this fan. Personnel should have a clear understanding of these instructions and should be aware of general safety precautions. Improper installation can result in electric shock, possible injury due to coming in contact with moving parts, as well as other potential hazards. Other considerations may be required if high winds or seismic activity are present. If more information is needed, contact a licensed professional engineer before moving forward.

1. Follow all local electrical and safety codes, as well as the National Electrical Code (NEC) and the National Fire Protection Agency (NFPA), where applicable. Follow the Canadian Electrical Code (CEC) in Canada.
2. The rotation of the wheel is critical. It must be free to rotate without striking or rubbing any stationary objects.
3. Motor must be securely and adequately grounded.
4. Do not spin fan wheel faster than max cataloged fan rpm. Adjustments to fan speed significantly effects motor load. If the fan RPM is changed, the motor current should be checked to make sure it is not exceeding the motor nameplate amps.
5. Do not allow the power cable to kink or come in contact with oil, grease, hot surfaces or chemicals. Replace cord immediately if damaged.
6. Verify that the power source is compatible with the equipment.

7. Never open access doors to a duct while the fan is running.

DANGER

Always disconnect, lock and tag power source before installing or servicing. Failure to disconnect power source can result in fire, shock or serious injury.

CAUTION

When servicing the fan, motor may be hot enough to cause pain or injury. Allow motor to cool before servicing.

CAUTION

Precaution should be taken in explosive atmospheres.

DANGER

Pour écarter les risques d'incendie, de choc électrique ou de blessure grave, veiller à toujours débrancher, verrouiller et étiqueter la source de courant avant l'installation ou l'entretien.

ATTENTION

Lors de toute intervention sur la soufflante, le moteur peut être suffisamment chaud pour provoquer une douleur voire une blessure. Laisser le moteur refroidir avant toute maintenance.

ATTENTION

Faire preuve de précaution dans les atmosphères explosives.

Receiving

Upon receiving the product check to make sure all items are accounted for by referencing the delivery receipt or packing list. Inspect each crate or carton for shipping damage before accepting delivery. Alert the carrier of any damage detected. The customer will make a notation of damage (or shortage of items) on the delivery receipt and all copies of the bill of lading which is countersigned by the delivering carrier. If damaged, immediately contact your Accurex Representatives. Any physical damage to the unit after acceptance is not the responsibility of Accurex, LLC.

Unpacking

Verify that all required parts and the correct quantity of each item have been received. If any items are missing, report shortages to your local representative to arrange for obtaining missing parts. Sometimes it is not possible that all items for the unit be shipped together due to availability of transportation and truck space. Confirmation of shipment(s) must be limited to only items on the bill of lading.

Handling

Fans are to be rigged and moved by the lifting brackets provided or by the skid when a forklift is used. Location of brackets varies by model and size. Handle in such a manner as to keep from scratching or chipping the coating. Damaged finish may reduce the ability of the fan to resist corrosion.

Fans should never be lifted by the shaft, fan housing, motor, belt guard, windband or accessories.

Storage

Fans are protected against damage during shipment. If the unit cannot be installed and operated immediately, precautions need to be taken to prevent deterioration of the unit during storage. The user assumes responsibility of the fan and accessories while in storage. The manufacturer will not be responsible for damage during storage. The following suggestions are provided solely as a convenience to the user.

INDOOR - The ideal environment for the storage of fans and accessories is indoors, above grade, in a low humidity atmosphere which is sealed to prevent the entry of blowing dust, rain, or snow. Temperatures should be evenly maintained between 30°F (-1°C) and 110°F (43°C) (wide temperature swings may cause condensation and “sweating” of metal parts). All accessories must be stored indoors in a clean, dry atmosphere.

Remove any accumulations of dirt, water, ice or snow and wipe dry before moving to indoor storage. To avoid “sweating” of metal parts allow cold parts to reach room temperature. To dry parts and packages use a portable electric heater to get rid of any moisture build up. Leave coverings loose to permit air circulation and to allow for periodic inspection.

The unit should be stored at least 3½ inches (89 mm) off the floor on wooden blocks covered with moisture proof paper or polyethylene sheathing. Aisles between parts and along all walls should be provided to permit air circulation and space for inspection.

OUTDOOR - Roads or aisles for portable cranes and hauling equipment are needed.

The fan should be placed on a level surface to prevent water from leaking into the fan. The fan should be elevated on an adequate number of wooden blocks so that it is above water and snow levels and has enough blocking to prevent it from settling into soft ground. Locate parts far enough apart to permit air circulation, sunlight, and space for periodic inspection. To minimize water accumulation, place all fan parts on blocking supports so that rain water will run off.

The use of a tarp to cover the unit will aid in keeping it clean and dry. Avoid using a black plastic tarp as it will promote condensation.

Fan wheels should be blocked to prevent spinning caused by strong winds.

Inspection & Maintenance during Storage

While in storage, inspect fans once per month. Keep a record of inspection and maintenance performed.

If moisture or dirt accumulations are found on parts, the source should be located and eliminated. At each inspection, rotate the wheel by hand ten to fifteen revolutions to distribute lubricant on motor. If paint deterioration begins, consideration should be given to touch-up or repainting. Fans with special coatings may require special techniques for touch-up or repair.

Machined parts coated with rust preventive should be restored to good condition promptly if signs of rust occur. Immediately remove the original rust preventive coating with petroleum solvent and clean with lint-free cloths. Polish any remaining rust from surface with crocus cloth or fine emery paper and oil. Do not destroy the continuity of the surfaces. Wipe clean thoroughly with Tectyl® 506 (Ashland Inc.) or the equivalent. For hard to reach internal surfaces or for occasional use, consider using Tectyl® 511M Rust Preventive or WD-40® or the equivalent.



REMOVING FROM STORAGE

As fans are removed from storage to be installed in their final location, they should be protected and maintained in a similar fashion, until the fan equipment goes into operation.

Prior to fully assembling and installing the fan and system components, inspect the fan assembly to make sure it is in working order.

1. Check all fasteners, set screws, wheel, bearings, drive, motor base and accessories for tightness.
2. Rotate the fan wheel by hand and assure no parts are rubbing. Access to the wheel is obtained through an access panel located on the side of the fan housing.
3. Ensure proper wheel settings for radial gap and alignment. See Unit Start-Up section.

Table of Contents

General Safety Information	1
Receiving, Unpacking, Handling.	2
Storage - Indoor / Outdoor	2
Inspection and Maintenance during Storage	2
Removing from Storage	3
Installation	
Ducted Installations	4
Non-Ducted Installations	4
Duct Connections	4
Mounting Configurations	
Universal Mounting	5
Mounting Rails (Optional)	5-6
Ceiling Hung - Horizontal or Vertical	6
Base Mount - Horizontal or Vertical	6
Installation for UL 762 Restaurant Exhaust	
Installation Overview	6-7
Cleaning, Maintenance, Repair	7
Unit Start-Up.	7
Radial Gap and Alignment	7
Vibration	7
Maintenance	
V-Belt Drive	9
V-Belt Replacement	9
Motors	10
Fan Bearing Replacement.	10
Fan Bearing Lubrication.	10
Troubleshooting	11
Our Commitment.	Backcover



Installation

Installations with poor inlet or discharge configurations may result in reduced fan performance.

Ducted Installations

Inlet Duct Turns – Installation of a duct turn or elbow too close to the fan inlet reduces fan performance. Restricted or unstable flow at the fan inlet can cause pre-rotation of incoming air or uneven loading of the fan wheel, yielding large system losses and increased sound levels. To achieve full fan performance, there should be at least one fan wheel diameter between the turn or elbow and the fan inlet.

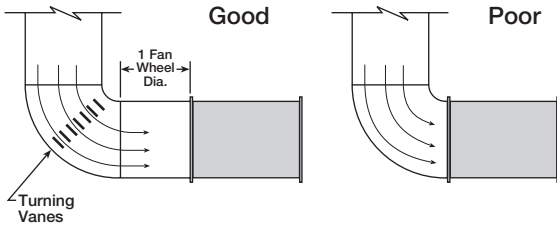

Discharge Duct Turns – Fan performance is reduced when duct turns are made immediately off the fan discharge. To achieve cataloged fan performance there should be at least three equivalent duct diameters of straight ductwork between the fan discharge and any duct turns.

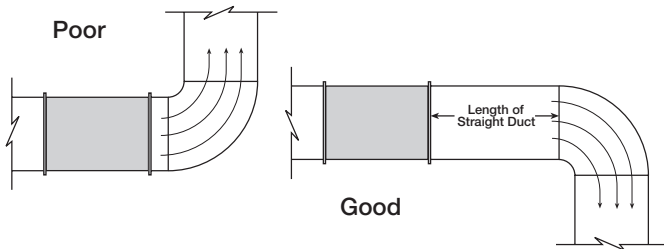

Non-Ducted Installation

Inlet Clearance

Installation of a fan with an open inlet too close to a wall or bulkhead will cause reduced fan performance. It is desirable to have a minimum of one fan wheel diameter between the fan inlet and the wall.

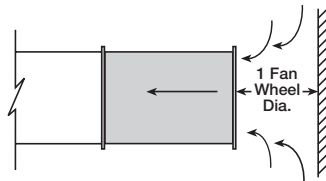

Free Discharge

Free or abrupt discharge into a plenum results in a reduction in fan performance. The effect of discharge static regain is not realized, and performance is reduced.

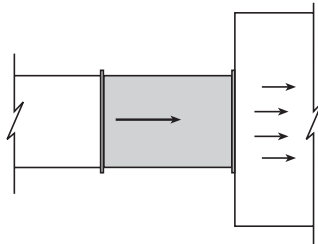

Duct Connections

It is highly recommended to use a flexible sleeve connection instead of a rigid duct connection. This will reduce vibration transmission through the ductwork.

Slip-Fit End Connection

Directly attach the flexible sleeve to the duct and fan. No additional parts are required.

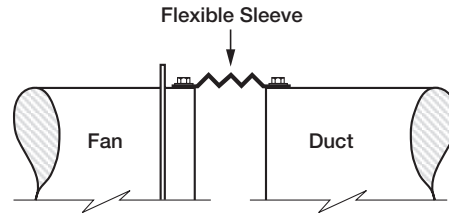

Flanged End Connection

Optional companion flanges are bolted to the fan to provide a slip-fit connection for a flexible sleeve.

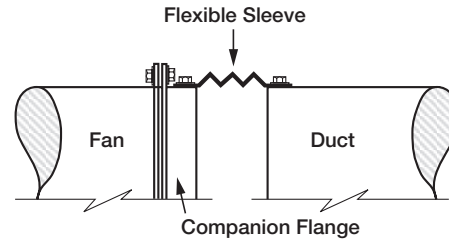

Note: Flexible sleeve & attachment hardware not provided.



Mounting Configurations

XQEI-I/II Sizes 9-27

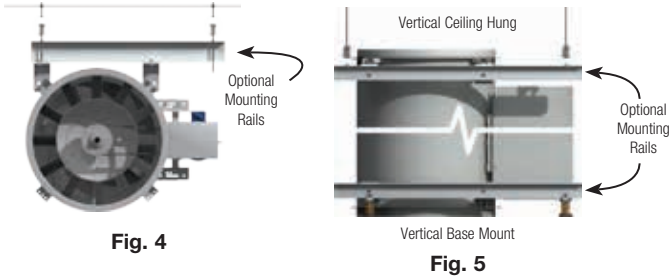
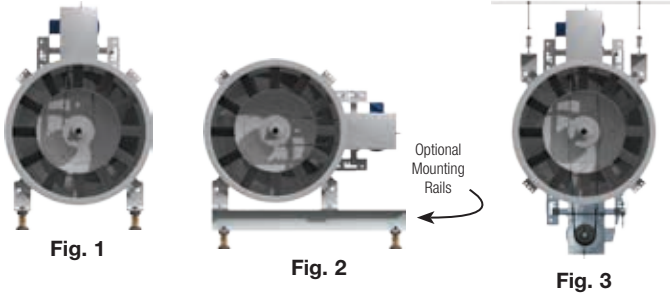

Universal Mounting

XQEI-I/II models sizes 9 thru 27 can be mounted horizontally or vertically. For ease of installation, eight mounting brackets are welded on each fan. **Motor positions are viewed from the discharge end.**

Fig. 1 Horizontal Base Mount: Each fan is shipped as standard in this arrangement. Motor at “A” position (12 o’clock) is standard.

Fig. 2 Horizontal Base Mount with motor at “C” or “G” position (3 or 9 o’clock). Mounting rails are recommended for this installation.

Fig. 3 Horizontal Ceiling Hung: In this installation the supports can be positioned for mounting the motor at “A” or “E” (12 or 6 o’clock).

Fig. 4 Horizontal Ceiling Hung with motor at “C” or “G” (3 or 9 o’clock). Mounting rails are recommended for this installation.

Fig. 5 Vertical Mount: Universal XQEI fans can be mounted vertically (ceiling hung or base mount) for either upward or downward airflow. Mounting rails are suggested for any vertical installation.

XQEI-I/II Sizes 30 thru 60

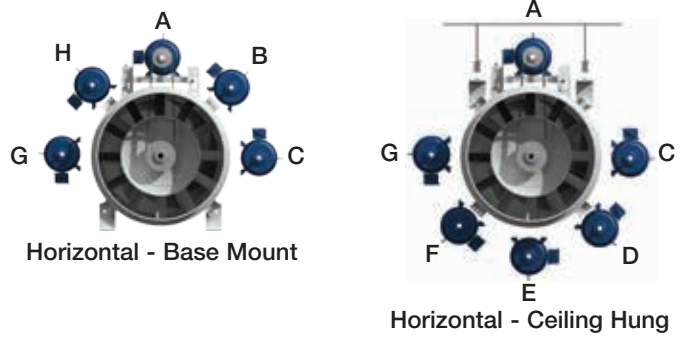

Horizontal Mounting configurations, base mount or ceiling hung, are provided with an identical support. The mounting configuration can be changed between base mount or ceiling hung in the field. The motor position can also be field rotated to any of the shown positions. Motor positions are viewed from the discharge end.

Mounting rails are recommended for horizontal installations with B, C, D, F, G and H motor positions.

Vertical Mounting configurations, upblast or downblast, are provided with heavy duty steel brackets welded to both ends. These brackets permit either floor or ceiling mounting on the same unit. Mounting rails are suggested for any vertical installation for sizes 30-60.

NOTE

Mounting rails are not required for vertical installations on sizes 30 thru 60.

Mounting Rails (Optional)

Mounting rails, when supplied with the fan, are either a single piece formed channel or a two piece formed channel assembly with overlapping sides. Rails are supplied with predrilled mounting holes and hardware to attach fan.

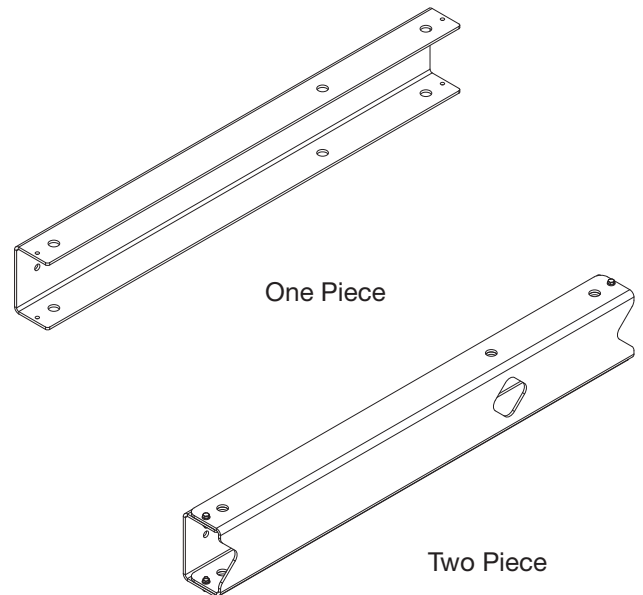

Mounting Rails (Optional) - continued

Rails are designed to accommodate fan installations in a vertical or horizontal configuration. See the figures below illustrating rail orientation for each configuration.

Ceiling Hung - Horizontal

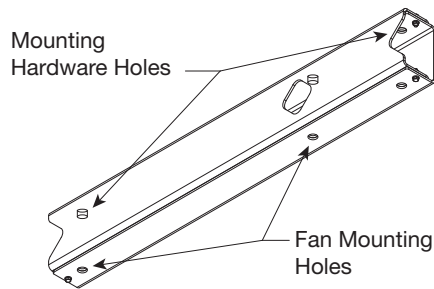

Ceiling Hung - Vertical

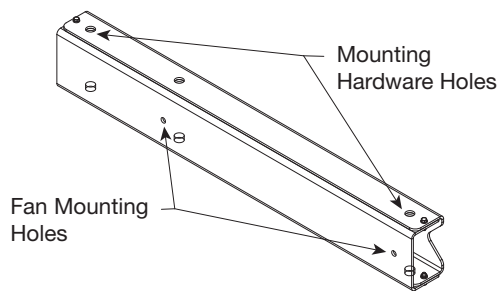

Base Mount - Horizontal

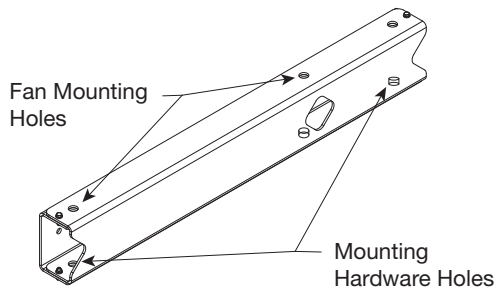

Base Mount - Vertical

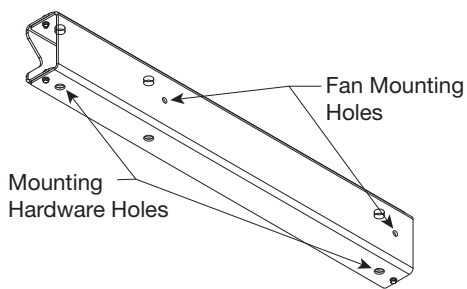

After mounting the fan to the rails, remaining mounting hardware is installed in unused holes located in overlapping sides (two piece rails only).

Installation for UL 762 Restaurant Exhaust

- All units used in applications with grease laden air are to be installed in accordance to NFPA 96, IMC 2203 and local codes. Consult local code authorities for your specific requirements.
- Fans shall be located in an easily accessible area of adequate size to allow for service or removal. Exhaust fans with ductwork connected to both ends shall have access for cleaning and inspection within 3 ft. (0.92 m) of each end of the fan (NFPA 96).
- Maintain a minimum clearance of at least 18 inches (457 mm) to combustible material and 6 inches (125.4 mm) to either limited-combustible or noncombustible material (NFPA 96).
- Fans are to be installed with the motors in the 3 or 9 o'clock (C or G) positions. Motors located in this configuration may cause an unbalanced load that should be considered if isolators are to be used. Equalized loading between isolators can be achieved through the use of mounting rails.
- It is recommended to install the fan near the end of the duct run. This limits the amount of positive pressure in the system. The diagram below illustrates an inline fan exhausting air near the final termination point. See local codes and NFPA 96 for any restrictions and requirements for wall terminations.

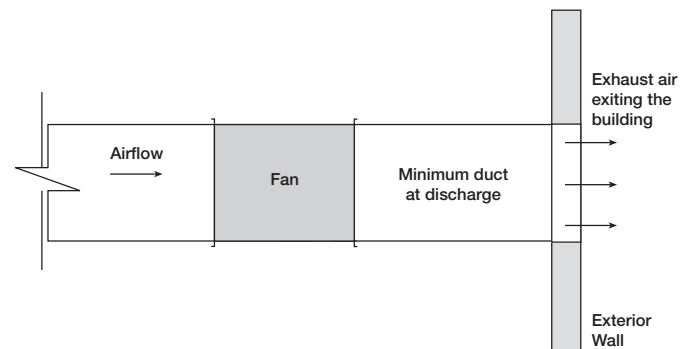

- A drain is provided for single-point drainage of water and residue. When installed correctly, housing drains will be located on the bottom. This drain is used to remove any accumulated grease and / or cleaning solutions. Some means for collection of this residue must be provided, either a container directly under the drain or use an adapter and pipe to carry the residue to a remote collection point. Remove drain plug prior to connection to grease collection device.
- Provision to open and remove the access door is required for periodic cleaning and maintenance. The access door is clearly labeled and indicates that access to this location must be maintained. Any enclosure openings required to reach the access panel shall be large enough to allow for the removal of the panel.



Installation for UL 762 Restaurant Exhaust - *continued*

- Inline fans shall be connected to the exhaust duct by flanges securely bolted as shown in the figures below (NFPA 96). Flexible connectors shall not be used. Units supplied with matching companion flanges are to have this part welded to the ductwork and then bolted to the fan. Gaskets used in the Overlapping Connection style shall not be positioned in a manner to have direct contact with the grease.

Overlapping Connection

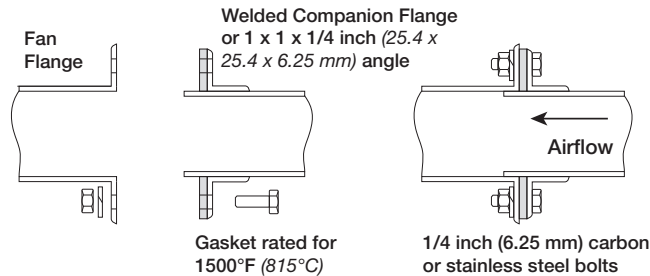

Sealant Connection

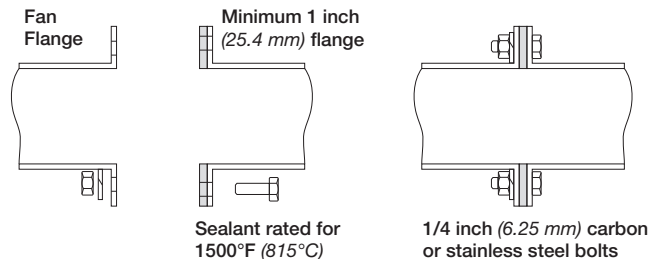

Cleaning, Maintenance and Repair

Cleaning of Internal Components

- Entire wheel should be cleaned during routine duct cleaning. Partial cleaning may result in an unbalanced wheel that can cause premature bearing failure or excessive vibration.
- Grease / cleaning solution should drain freely through the provided drain connection. Remove any obstructions inhibiting proper drainage.
- Only the access door is removed during routine duct cleaning. The bearing cover is not removed during routine cleaning. The bearing cover is removed only when inspecting or changing the bearings, fan shaft or driven pulley.

Bearing Lubrication

See bearing manufacturer's instructions or label on the fan housing for lubrication schedule. Lubricate bearings with high temperature grease conforming to NLGI Grade 2 such as Mobil Mobilith SHC 100 or 200.

Sealant / Gasket / Seal Replacement

Fan to Duct Sealant / Gasket Replacement - Repair or replace sealant / gasket as needed. Replacement sealant or gasket shall be rated for 1500°F (815°C) and shall be grease tight such as 3M Fire Barrier 2000+ Silicone Sealant. See Sealant and Overlapping Connection figures for proper installation.

Access Door / Bearing Cover Gasket Replacement - Replace access door or bearing cover gasket material as needed. Gasket material for the access door is 1/2 x 1/2 inch (12.7 x 12.7 mm) Accurex part number 220145. Gasket for the bearing cover is 1/8 x 1/2 inch (3.17 x 12.7 mm) Accurex part number 220144. Both items are ordered by the foot.

Mechanical Seal

A mechanical seal, located inside the bearing cover, is used to keep grease from penetrating into this area. Contact Accurex with the fan's serial number for appropriate sizing and part number for a replacement mechanical seal.

Unit Start-Up

DANGER

High voltage electrical input is needed for this equipment. This work should be performed by a qualified electrician.

DANGER

Cet appareil nécessite une alimentation électrique sous haute tension. Confier ce travail à un électricien qualifié.

DANGER

Disconnect and secure to the "OFF" position all electrical power to the fan prior to inspection or servicing. Failure to comply with this safety precaution could result in serious injury or death.

DANGER

Pour écarter les risques de blessure grave ou de mort, débrancher et verrouiller l'alimentation électrique en position « Arrêt » avant tout contrôle ou entretien.

1. Disconnect and lock-out all power switches to fan.
2. Check all fasteners, set screws and locking collars on the fan, wheel, bearings, drive, motor base and accessories for tightness.
3. Rotate the fan wheel by hand and assure no parts are rubbing.
4. Check for bearing alignment and lubrication.
5. Check the V-belt drive for proper alignment and tension.
6. Check all guarding (if supplied) to ensure that it is securely attached and not interfering with rotating parts.
7. Check all electrical connections for proper attachment.
8. Check housing and ductwork, if accessible, for obstructions and foreign material that may damage the fan wheel.
9. Check for proper wheel rotation by momentarily energizing the fan. Rotation should correspond to the rotation decal affixed to the unit (counter clockwise rotation is correct as viewed from the fan inlet).

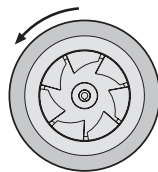

Mixed Flow

One of the most frequently encountered problems with fans are motors which are wired to run in the wrong direction. This is especially true with 3-phase installations where the motor will run in either direction, depending on how it has been wired. To reverse rotation of a 3-phase motor, interchange any two of the three electrical leads. Single phase motors can be reversed by changing internal connections as described on the motor label or wiring diagram.

10. Fans with multi-speed motors should be checked on low speed during initial start-up.
11. Ensure proper wheel location for radial gap, and alignment. See Radial Gap and Alignment section below.
12. Grease may be forced out of the bearing seals during initial start-up. This is a normal self-purging feature of the bearing.
13. Check for unusual noise, vibration or overheating of bearings. Refer to the Troubleshooting section of this manual if a problem develops.

Radial Gap and Alignment

Efficient fan performance can be maintained by having the correct radial gap, overlap and alignment. These items should be checked before start-up and after the fan has been in operation for 24 hours.

Radial Gap - Adjust inlet cone position such that the radial gap between the wheel cone and inlet cone is evenly distributed around the wheel.

Alignment - If necessary, adjust wheel position by loosening the wheel hub from the fan shaft so that a straight edge held tight to the wheel cone just touches the inlet cone. Refer to drawing.

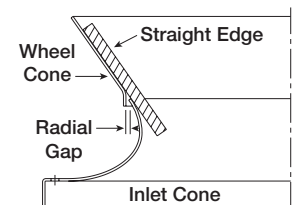

Vibration

Excessive vibration is the most frequent problem experienced during initial start-up. Left unchecked, excessive vibration can cause a multitude of problems, including structural and/or component failure.

The most common sources of vibration are:

- Wheel unbalance
- Drive pulley misalignment
- Incorrect belt tension
- Bearing misalignment
- Mechanical looseness
- Faulty belts
- Foundation stiffness
- Drive component unbalance
- Poor inlet/outlet conditions

Many of these conditions can be discovered by careful observation. Refer to the Troubleshooting section of this manual for corrective actions. If observation cannot locate the source of vibration, a qualified technician using vibration analysis equipment should be consulted. If the problem is wheel unbalance, in-place balancing can be done providing there is access to the fan wheel. Any correction weights added to the wheel should be welded to either the wheel back (single-plane balance) or to the wheel back and wheel cone (two-plane balance).



Maintenance

DANGER

Disconnect and secure to the "OFF" position all electrical power to the fan prior to inspection or servicing. Failure to comply with this safety precaution could result in serious injury or death.

DANGER

Pour écarter les risques de blessure grave ou de mort, débrancher et verrouiller l'alimentation électrique en position « Arrêt » avant tout contrôle ou entretien.

Once the unit has been put into operation, a routine maintenance schedule should be set up to accomplish the following:

1. Lubrication of bearings and motor.
2. Wheel, housing, bolts and set screws on the entire fan should be checked for tightness.
3. Any dirt accumulation on the wheel or in the housing should be removed to prevent unbalance and possible damage.
4. Springs should be checked for breaks and fatigue. Rubber isolators should be checked for deterioration.
5. Inspect fan impeller and housing looking for fatigue, corrosion or wear.

IMPORTANT

Changing the belts or drives can significantly increase the amp draw of the motor. If changes are made to the drives or belts, the amps must be checked to assure no overamping.

V-Belt Drives

V-belt drives must be checked on a regular basis for wear, tension, alignment and dirt accumulation. Premature or frequent belt failures can be caused by improper belt tension (either too loose or too tight) or misaligned sheaves. Abnormally high belt tension or drive misalignment will cause excessive bearing loads and may result in failure of the fan and/or motor bearings. Conversely, loose belts will cause squealing on start-up, excessive belt flutter, slippage and overheated sheaves. Either excessively loose or tight belts may cause fan vibration.

When replacing V-belts on multiple groove drives, all belts should be changed to provide uniform drive loading. Do not pry belts on or off the sheave. Loosen belt tension until belts can be removed by simply lifting the belts off the sheaves. After replacing belts, ensure that slack in each belt is on the same side of the drive. Belt dressing should never be used.

Do not install new belts on worn sheaves. If the sheaves have grooves worn in them, they must be replaced before new belts are installed.

The proper tension for operating a V-belt drive is the lowest tension at which the belts will not slip at peak load conditions. Belts are adjusted by raising or lowering the motor pivot plate. For initial tensioning, the proper belt deflection half-way between sheave centers is 1/64 of the belt span. For example, if the belt span is 64 inches, the belt deflection should be 1 inch using moderate thumb pressure at mid-point of the drive.

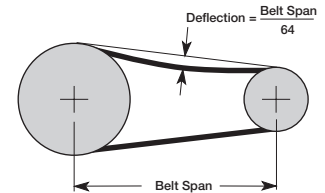

Check belt tension two times during the first 24 hours of operation and periodically thereafter.

V-Belt Replacement

The V-belt drive components, when supplied by Accurex, have been carefully selected for this unit's specific operating condition. Changing V-belt drive components could result in unsafe operating conditions which may cause personal injury or failure of fan components.

1. Remove the protective coating from the end of the fan shaft using mineral spirits or another similar solvent. Check to ensure that the shaft is free of nicks and burrs.
2. Slide sheaves on shafts. Do not drive sheaves on as this may result in bearing damage.
3. Align fan and motor sheaves with a laser, straight-edge or string and tighten.
4. Place belts over sheaves. Do not pry or force belts, as this could result in damage to the cords in the belts.
5. Adjust the tension until the belts appear snug. Run the unit for a few minutes (refer to unit start-up section) and allow the belts to "set" properly.
6. With the fan off, adjust the belt tension by moving the motor pivot plate. (Belts are adjusted by raising or lowering the motor pivot plate). When in operation, the tight side of the belts should be in a straight line from sheave to sheave with a slight bow on the slack side.



Motors

Motor maintenance is generally limited to cleaning and lubrication. Cleaning should be limited to exterior surfaces only. Removing dust and grease build-up on the motor housing assists proper motor cooling.

IMPORTANT

Do not allow water or solvents to enter the motor or bearings. Under no circumstances should motors or bearings be sprayed with steam, water or solvents.

Greasing of motor bearings is only required when fittings are provided. Many fractional motors are permanently lubricated and require no further lubrication. Motors supplied with grease fittings should be greased in accordance with the manufacturer's recommendations. When motor temperature does not exceed 104°F (40°C), the grease should be replaced after 2000 hours of running time.

Fan Bearing Replacement

Replacement of bearings requires disassembly of internal components. For this procedure, access must be available to both the inlet and outlet ends. The following procedure assumes belts have already been loosened and removed. (Belts are removed by adjusting the motor pivot plate).

Reinstall components in reverse order of removal. Reference the Radial Gap and Alignment section to ensure proper wheel installation.

If the bearings cannot be removed from the shaft due to corrosion or damage, the bearing plates can be removed from the inner chamber. The shaft/bearing/bearing plates can be removed as a complete assembly from the fan inlet.

1. Unbolt and remove inlet cone (inlet side).
2. Loosen set screws at the wheel hub and remove wheel (inlet side).
3. Remove bolts from drive bearing plate (outlet side).
4. Remove bolts from wheel bearing plate (inlet side).
5. Pull shaft/bearing/bearing plate assembly out of the fan housing (inlet side).
6. Replace bearings on shaft/bearing/bearing plate assembly.

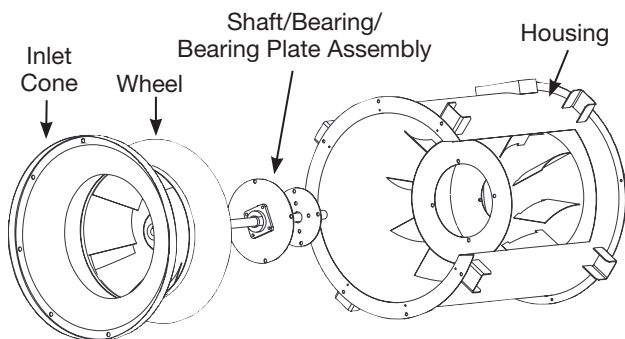

Fan Bearing Lubrication

The bearings are carefully selected to match the maximum load and operating conditions of the specific class, arrangement and fan size. The instructions provided in this manual and those provided by the bearing manufacturer will minimize any bearing problems. Bearings are the most critical moving part of the fan. Therefore, special care is required when mounting them on the unit and maintaining them.

Refer to the following chart and the manufacturer's instructions for grease types and intervals for various operating conditions. Never mix greases made with different bases. This will cause a breakdown of the grease and possible failure of the bearing.

Fan RPM	Recommended Fan Bearing Lubrication Schedule (in Months*)						
	Bearing Bore						
	½ - 1	1⅛ - 1½	1⅝ - 1⅞	1 ¹⁵ / ₁₆ - 2 ¹ / ₁₆	2 ² / ₁₆ - 3	3 ³ / ₁₆ - 3½	3 ¹⁵ / ₁₆ - 4½
To 250	6	6	6	6	6	5	4
500	6	6	6	5	4	3	3
750	6	5	4	3	3	2	2
1000	6	4	3	2	2	1	1
1250	5	3	2	1	1	0.5	0.5
1500	5	2	1	1	0.5	0.5	0.25
2000	5	1	1	0.5	0.25	0.25	0.25
2500	4	0.5	0.5	0.25	0.25	0.25	
3000	4	0.5	0.25	0.25	0.25		

*Suggested initial greasing interval is based on 12 hour per day operation and 150° F. maximum housing temperature. For continuous (24 hour) operation, decrease greasing interval by 50%.

- If possible, relubricate with grease while in operation without endangering personnel.
- For ball bearings (operating) relubricate until clean grease is seen purging at the seals. Be careful not to unseat the seal by over lubricating.
- For ball bearings (idle) add 1-2 shots of grease up to 2 in. bore sizes, and 4-5 shots of grease above 2 in. bore sizes with hand grease gun.
- For roller bearings, relubricate with 4 shots of grease up to 2 in. bore size, 8 shots for 2-5 in. bore size, and 16 shots above 5 in. bore size with hand grease gun.
- Adjust lubrication frequency based on condition of purged grease.
- A high quality lithium base grease conforming to NLGI Grade 2 consistency, such as those listed below, should be used.

- | | |
|------------------|----------------------|
| Mobilith SHC 220 | Texaco Multifak AFB2 |
| Mobilith AW2 | Texaco Premium RB |
| Shell Alvania #2 | Exxon Unirex N2 |

IMPORTANT

Lubricate bearings prior to periods of extended shutdowns or storage and rotate shaft monthly to aid in preventing corrosion. If the fan is stored more than three months, the bearings should be purged with new grease prior to start-up.



Troubleshooting

WARNING

Before taking any corrective action, make certain unit is not capable of operation during repairs.

AVERTISSEMENT

Avant d'entreprendre toute action corrective, s'assurer que l'appareil ne pourra pas fonctionner durant les réparations.

Problem	Cause	Corrective Action
Excessive Noise	Wheel Rubbing Inlet	Adjust wheel and/or inlet cone. Tighten wheel hub or bearing collars on shaft.
	V-Belt Drive	Tighten sheaves on motor/fan shaft. Adjust belt tension. Align sheaves properly (see page 9). Replace worn belts or sheaves.
	Bearings	Replace defective bearing(s). Lubricate bearings. Tighten collars and fasteners.
	Wheel Unbalance	Clean all dirt off wheel. Check wheel balance, rebalance in-place if necessary.
Volume Too Low	Fan	Check wheel for correct rotation. Increase fan speed.
	Duct System	See page 4.
Volume Too High	Fan	Decrease fan speed.
	Duct System	Resize ductwork. Access door, filters, grilles not installed.
Static Pressure Wrong	Duct system has more or less restriction than anticipated	Change obstructions in system. Use correction factor to adjust for temperature/altitude. Resize ductwork. Clean filters/coils. Change fan speed.
Excessive Power Consumption High Horsepower	Fan	Check rotation of wheel.
	Duct System	Resize ductwork. Check proper operation of face and bypass dampers. Check filters and access doors.
Fan Doesn't Operate	Electrical Supply	Check fuses/circuit breakers. Check for switches turned off or disconnected. Check for correct supply voltage.
	Drive	Check for broken belts. Tighten loose pulleys.
	Motor	Assure motor is correct horsepower and not tripping overload protector.
Bearings Overheated	Lubrication	Check for excessive or insufficient grease in the bearing.
	Mechanical	Replace damaged bearing. Relieve excessive belt tension. Align bearings. Check for bent shaft.
Excessive Vibration	Belts	Adjust tightness of belts. Replacement belts should be a matched set.
	System Unbalance	Check alignment of shaft, motor and pulleys. Adjustable pitch pulleys with motors over 15 hp motors are especially prone to unbalance. Check wheel balance, rebalance if necessary.



Our Commitment

As a result of our commitment to continuous improvement, Accurex reserves the right to change specifications without notice.

Specific Accurex product warranties are located on accurex.com within the product area tabs and in the Library under Warranties.



P.O. Box 410 Schofield, WI 54476
Phone: 800.333.1400 • Fax: 715.241.6191
Parts: 800.355.5354 • www.accurex.com