

## Installation, Operation and Maintenance Manual

Please read and save these instructions for future reference. Read carefully before attempting to assemble, install, operate or maintain the product described. Protect yourself and others by observing all safety information. Failure to comply with instructions could result in personal injury and/or property damage!

### KVS v2.00

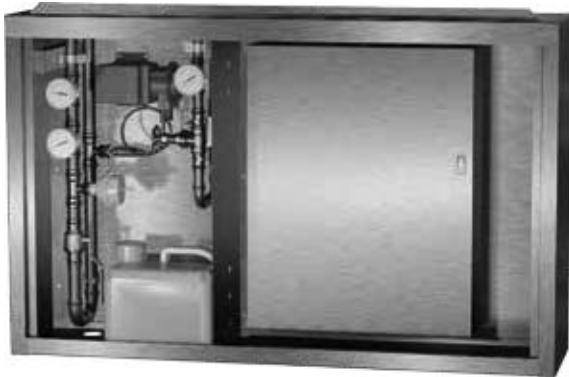

## General Safety Information

Only qualified personnel should install this product. Personnel should have a clear understanding of these instructions and should be aware of general safety precautions. Improper installation can result in electric shock, possible injury due to coming in contact with moving parts, as well as other potential hazards. If more information is needed, contact a licensed professional engineer before moving forward.

1. Follow all local electrical, plumbing and safety codes, as well as the National Electrical Code (NEC) and the latest edition of the National Fire Protection Agency Standard for Ventilation Control and Fire Protection of Commercial Cooking Operations (NFPA 96). Follow the Canadian Electrical Code (CEC) and ULC-S650 if installing this product in Canada.
2. Do not allow the electrical components of this unit to come in contact with oil, grease, hot surfaces, water, or chemicals.
3. Verify the site can supply the necessary power for each fan and for the control panel.

### WARNING

Electrical shock hazard. Can cause equipment damage, personal injury or death. Service must only be performed by personal that are knowledgeable in the operation of the equipment being controlled.

### DANGER

Always disconnect power before working on or near the product. Lock and tag the disconnect switch or breaker to prevent accidental power up.





### CAUTION

When servicing the product, variable frequency drives (if provided) may be hot enough to cause pain or injury. Allow motor to cool before servicing.

### CAUTION

It is the responsibility of the installer to make sure both electrical and gas appliances shut down in the event of a fire or in the event of a power loss to the building when this sequence is required by the authority having jurisdiction.

# Table of Contents

Receiving and Handling . . . . .	2	Wash Input . . . . .	14
Model Identification . . . . .	3	Duct Sump Solenoids . . . . .	14
System Components . . . . .	3	Power for Starters and Fans . . . . .	14
Installation		ASCP Connection Checklist . . . . .	15-16
Control Box Mounting . . . . .	4	Typical Electrical Connection Layout . . . . .	17
Temperature Sensor Mounting . . . . .	4	Sequence of Operation - ASCP-W . . . . .	18
Pneumatic Static Pressure Kit . . . . .	5	Sequence of Operation - ASCP-B and ASCP-K . . . . .	19
Keypad Mounting, Diagram and Dimensions . . . . .	5	Sequence of Operation - ASCP-V . . . . .	20
Touch Screen Mounting, Diagram and Dimensions . . . . .	6	Sequence of Operation - Fire and Alarm Operation . . . . .	21
Plumbing Connections		System Optimization - ASCP-V Panel Only . . . . .	21
Typical Plumbing Connection Layout . . . . .	7	Controller Setup and Tutorial . . . . .	22
Detergent Tank Installation . . . . .	7	Hood/System Status . . . . .	23
Detergent Requirements . . . . .	7	Example of Alarms . . . . .	24
Preventative Maintenance (Detergent Pump) . . . . .	7	Menus	
Electrical Connections		A.  Fan Status . . . . .	25
Power for Auto Scrubber Control Panel (ASCP) . . . . .	8	B.  Clock . . . . .	26
Power for Lights . . . . .	8	C.  Input/Output . . . . .	26
Variable Frequency Drives (VFD) . . . . .	8	D.  Service . . . . .	27-36
Vari-Green® Fan Wiring . . . . .	9	E.  Manufacturer . . . . .	36-39
VFD Provided by Others, Control Wiring . . . . .	9	Initial System Start-Up . . . . .	40
Make-Up Air VFD in ASCP Wiring . . . . .	9	Wash Operation & Wash Sequence of Operation . . . . .	41-43
Make-Up Air VFD in Make-Up Air Wiring . . . . .	9	Keypad Navigation . . . . .	44
Auto Tempering . . . . .	10	Touch Screen Navigation . . . . .	45-46
Fire System Microswitch . . . . .	10	General Information . . . . .	46
Hood Solenoids and Temperature Sensors . . . . .	10-11	Settings . . . . .	46-50
Keypad . . . . .	11	Configuration . . . . .	50-51
Touch Screen . . . . .	11	Information . . . . .	52
Remote Enable . . . . .	11	Troubleshooting . . . . .	53-54
Shunt Trip . . . . .	11	Variable Frequency Drive (VFD) Information . . . . .	55
Electric Gas Valve with Gas Reset . . . . .	11	Model V1000 Changing Parameters and Monitor	
Spare Fire Relay Contacts . . . . .	11	Motor Frequency and Motor Current . . . . .	56
Grease Trapper Pollution Control Unit (PCU)		Model A1000 Changing Parameters and Monitor	
Filter Status . . . . .	12	Motor Frequency and Motor Current . . . . .	56
High Temperature Alarm Contacts . . . . .	12	Building Management System (BMS) Points List	
Airflow Proving Switch(es) . . . . .	12	ASCP v2.00 Modbus/BACnet® . . . . .	57-59
System Wash Contacts . . . . .	13	ASCP v2.00 LonWorks® . . . . .	60-61
System Fan Contacts . . . . .	13	Maintenance Log . . . . .	62-63
Exhaust/Supply Fan Contacts . . . . .	13	Our Commitment . . . . .	Backcover
Fan Input . . . . .	13		

## Receiving and Handling

### Receiving

Upon receiving the product, check to make sure all items are accounted for by referencing the bill of lading to ensure all items were received. Notify the carrier if any damage is noticed. The carrier will make notification on the delivery receipt acknowledging any damage to the product. All damage should be noted on all of the copies of the bill of lading which is countersigned by the delivering carrier. If damaged upon arrival, file a claim with the carrier. Any physical damage to the unit after acceptance is not the responsibility of the manufacturer.

### Unpacking

Verify that all required parts and the correct quantity of each item have been received. If any items are missing, report shortages to your local representative to arrange for obtaining missing parts.

### Storage

If a ASCP must be stored prior to installation, it must be protected from dirt and moisture. Indoor storage is highly recommended.

<b>NOTE</b>
Improper storage which results in damage to the unit will void the warranty.

### Handling

Make sure the equipment does not suffer any heavy vibration or knocks.

## Model Identification

### ASCP-W

#### Auto Scrubber Wash Only – No Fan Controls

This configuration does not include any fan controls, and will only be responsible for washing the hoods and/or duct sumps. All fan controls and starters/VFDs are to be provided in the field.

### ASCP-B

#### Auto Scrubber Basic On/Off Fan Controls, Fan Starters/VFDs by Others

This configuration includes wash control of hoods and/or duct sumps, and also is provided with fan control in the form of simple dry contacts that can be used to tie into fan starters/VFDs. All fan starters/VFDs are to be provided in the field. Relay contacts to engage starters/VFDs are rated up to 8 amps and 250 VAC.

### ASCP-K

#### Auto Scrubber Kitchen Fan Control Center (XFCC)

This configuration includes wash control of hoods and/or duct sumps, and also provides fan controls with fan starters (this panel is integrated with a constant volume, fan control center).

### ASCP-V

#### Auto Scrubber Vari-Flow (Variable Volume)

This configuration includes wash control of hoods and/or duct sumps, and also provides fan controls with VFDs (this panel is integrated with the “Vari-Flow” variable volume functionality).

## System Components

### Auto Scrubber Control Panel (ASCP)

The control cabinet contains the water and electrical components, including the Programmable Logic Controller (PLC), that controls wash sequencing and operations. The control cabinet also includes the detergent reservoir, detergent pump, and other water piping.

### Backflow Preventer

A backflow preventer will be shipped loose with the ASCP and will need to be installed in-line with the hot water supply to the ASCP to prevent detergent from back-feeding into the building water supply. Plumbing instructions begin on page 6.

### User Interface

The user interface will be either a keypad with LCD screen or touch screen. It can be mounted on the Auto Scrubber control cabinet, hood or shipped loose for remote mounting. It will provide a WASH button (WASH ON/OFF with touch screen), and a means of turning on/off hood fans and lights, if applicable. It also includes system alarm notifications to alert of any faults on the system, such as low detergent alarm.

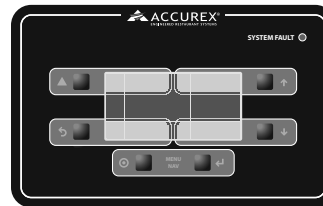

Keypad



Touch Screen

### NOTE

Control panel will be shipped with (and will be controlling) either an Auto Scrubber hood, duct sump, or a combination of both. For more detailed information on the Auto Scrubber hood or duct sump, please refer to the Accurex website at [www.accurex.com](http://www.accurex.com)

# Installation

## Control Box Mounting

1. Locate an area with enough space to mount the control box and fasten to the wall.

### NOTE

Control box may be factory mounted. If so, continue to the next section.

### NOTE

If the ASCP is configured for variable volume (ASCP-V) and the panel is equipped with static pressure control, it will be located in the ASCP. Therefore, this control box should be mounted in the space to be controlled. Refer to the Pneumatic Static Pressure Kit section for installation instructions of the pressure sensor kit on page 5.

## Temperature Sensor(s) Mounting

- if equipped

### NOTE

Temperature sensor(s) may be factory installed. If so, continue to the next section.

1. Locate flat space at the top interior of the hood in front of the filters, towards the front of the hood.

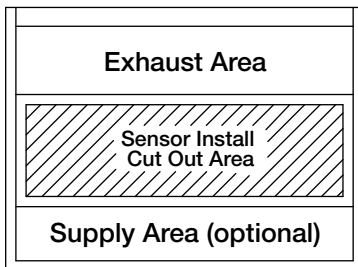

Top View of Exhaust Hood

2. Find a spot for the sensor in the flat space that will not interfere with the fire suppression nozzles and that is not within 12 inches (304.8 mm) of any light fixtures. Cut a 3/4 to 7/8-inch (19.0 to 22.2 mm) diameter hole in the flat spot of the capture tank.

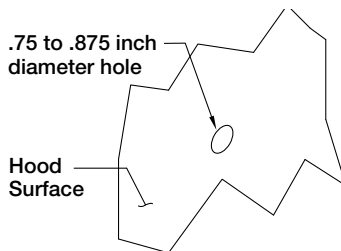

3. Center the octagon extension over the hole on the hood surface.

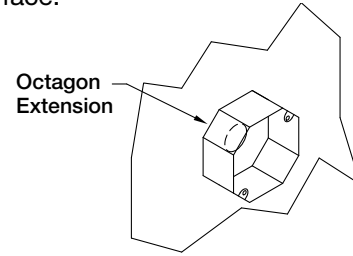

4. Insert the compression seal into the hole from the inside of the hood making sure the gasket is placed on the fitting before inserting it into the hole. Place the octagon box and J-box plate provided over the fitting on the top of the hood, keeping the fitting centered in the box. Install the lock washer and 1-1/2 inch (38.1 mm) nut on the threaded portion of the compression seal and tighten securely.

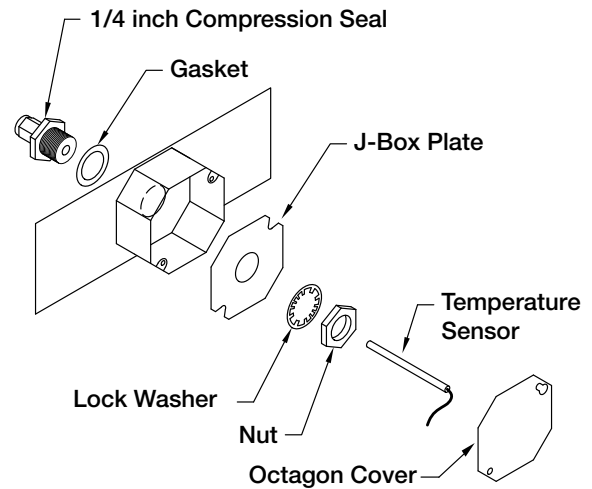

5. Insert the temperature sensor into compression seal and tighten to 35 ft-lbs (47.5 Nm).
6. Place octagon cover onto J-box plate and fasten it.



## Pneumatic Static Pressure Kit

- if equipped

1. Locate the Kele® static pressure sensor outside of the building in a secure location free from as many obstructions as possible.
2. Refer to the instruction manual with the static pressure sensor for installation and operation details.
3. Once the static pressure probe is mounted, run vinyl tubing from the probe back to the control panel and coil the excess tubing. Do not kink or trim the tubing.
4. If the control panel is located in the space to be controlled, go to the next section. If the control panel is mounted remotely from the space to be controlled, continue to step 5.
5. Run 1/4 inch (6.4 mm) virgin poly tubing (by others) from the sensor in the control panel to a secure location in the space to be controlled.

## Keypad Mounting - if equipped

### NOTE

The keypad may be factory mounted. If so, continue to the Electrical Connections section.

1. For systems with remote controls or keypad, a 35, 75, or 150 foot RJ25 cable is supplied to connect the keypad to the controls. The cable is plenum rated and does not need to be run through conduit unless required by local codes. If the keypad is to be mounted further away than the cable that is received, additional cable will be needed. Additional cable is available at the lengths mentioned above.

### Keypad Mounting Diagram

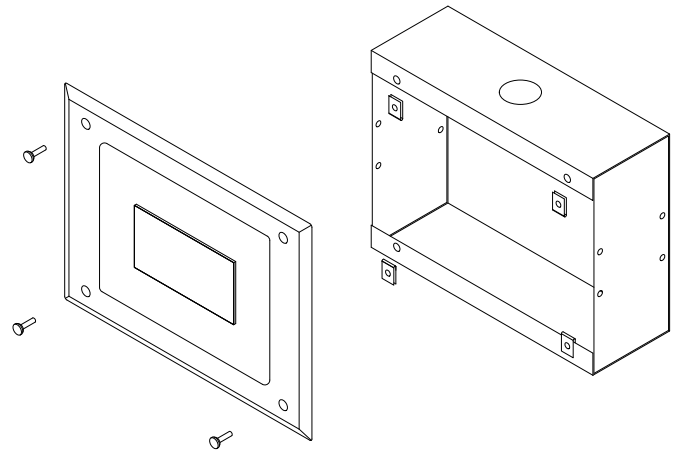

### Keypad Dimensions

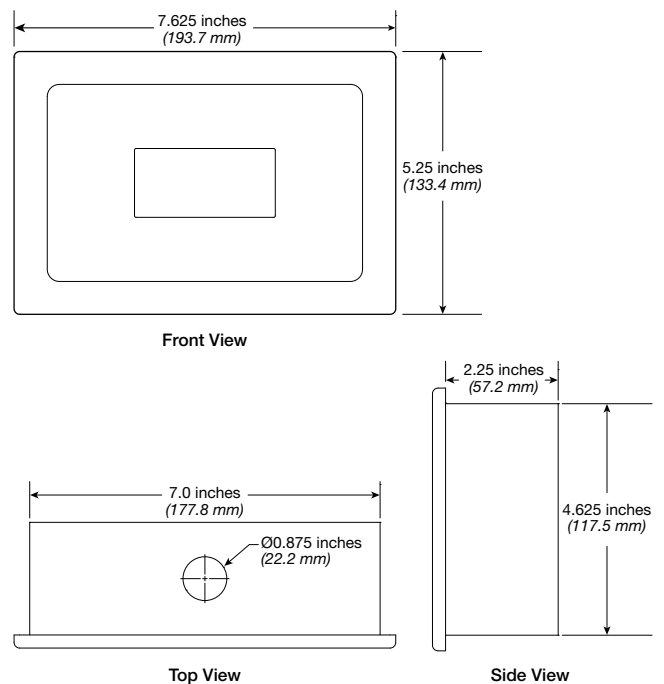

## Touch Screen Mounting - if equipped

### NOTE

The touch screen may be factory mounted. If so, continue to the Electrical Connections section.

- For systems with remote controls or touch screen, two 35, 75, or 150 foot sets of cables are supplied to connect the touch screen to the controls. The cables are plenum rated and do not need to be run through conduit unless required by local codes. If the keypad is to be mounted further away than the cable that is received, additional cable will be needed. Additional cables are available at the lengths mentioned above.

### Touch Screen Mounting Diagram

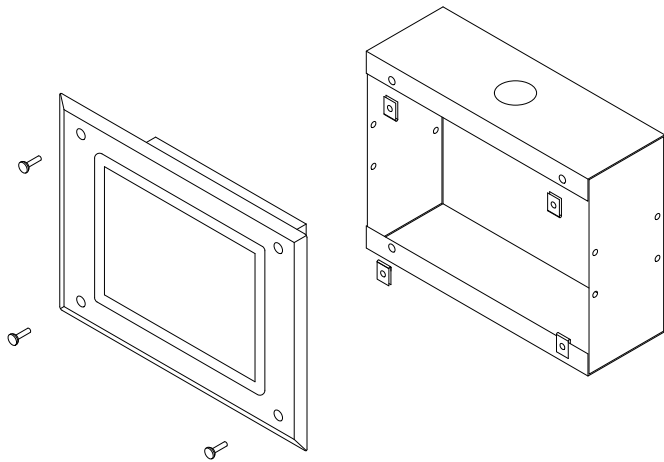

### Touch Screen Dimensions

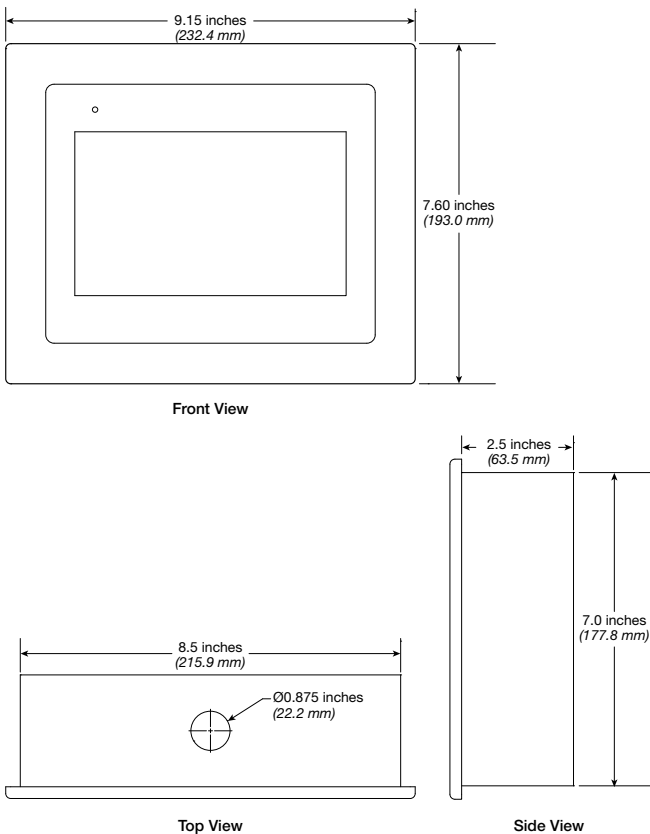

## Plumbing Connections

TOP VIEW OF AUTO SCRUBBER CONTROL PANEL (ASCP)

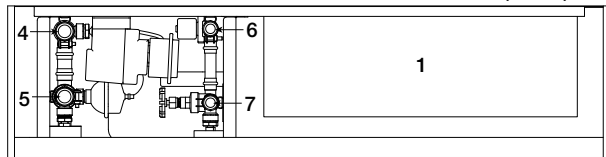

FRONT VIEW OF AUTO SCRUBBER CONTROL PANEL (ASCP)

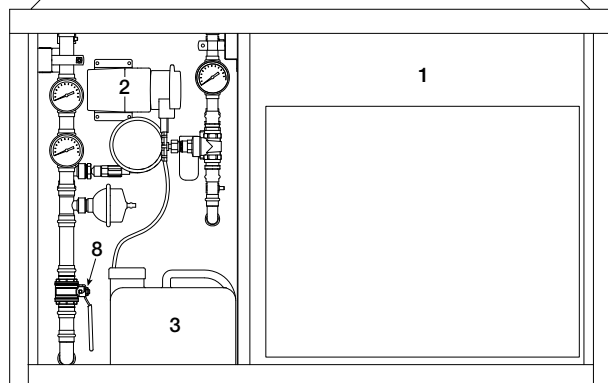

- |  |   |
|--|---|
| 1. Electrical Control Cabinet          | 5. Hot Water Inlet Connection           |
| 2. Detergent Pump                      | 6. Cold Water Outlet Connection to Hood |
| 3. Detergent Tank                      | 7. Cold Water Inlet Connection          |
| 4. Hot Water Outlet Connection to Hood | 8. Inlet Valve                          |

- Install the factory provided backflow preventer (shipped loose) and drain connection per local codes.

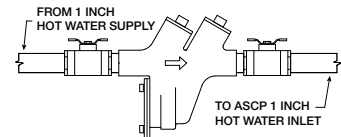

**Backflow Preventer**

- Bring 1-inch (25.4 mm) hot water supply line to the backflow preventer.
- Plumb 1-inch (25.4 mm) line from outlet of backflow preventer to the hot water inlet in the control cabinet.
- If the cabinet is remote mounted, connect the hot water outlet on the controls cabinet to the hot water inlet on the top of the hood.

If the control panel is washing duct sumps, connect the hot water outlet on the controls cabinet to all duct sump solenoids.

- If system is configured for cold water mist, bring 0.75-inch (19.05 mm) water piping to the cold water mist inlet in the control cabinet.
- If the cabinet is remote mounted and the system is configured for cold water mist, connect the cold water mist outlet on the controls cabinet to each hood with a cold water mist solenoid valve
- Plumb 2-inch (50.8 mm) drain on each hood to grease trap (floor).

### NOTE

- Hot water temperature should be 140°F (60°C).
- While the hood is washing, water pressure in the control panel should be between 40 and 70 PSI (275.8 and 482.6 kPa).
- Cold mist water pressure should be between 20 and 40 PSI (137.9 and 275.8 kPa).



# Plumbing Connections - continued

## Typical Plumbing Connection Layout

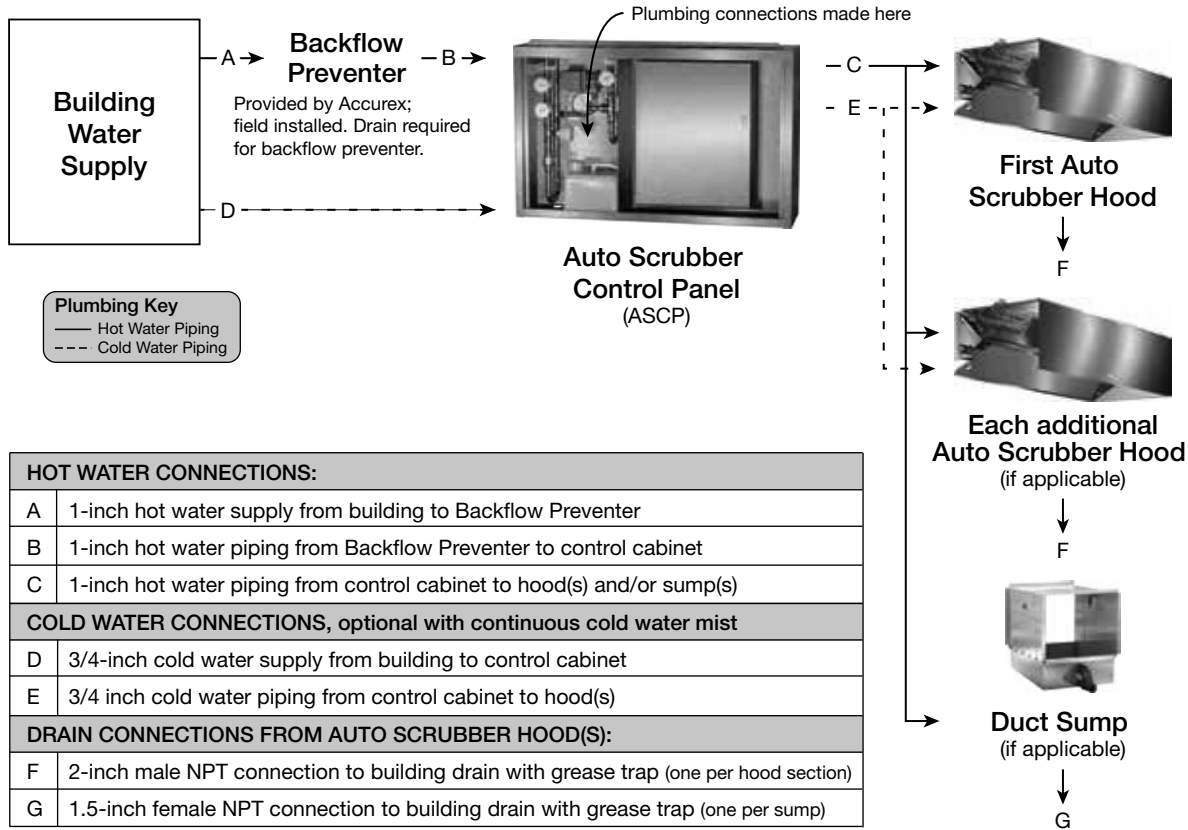

### Detergent Tank Installation

The detergent tank is located in the plumbing section of the ASCP. The tank provided can hold up to 2.5 gallons (9.5 liters) of detergent. It will need to be checked periodically depending on detergent use and filled with the recommended chemical detergent. The tank is also equipped with a float that will trigger an alarm to warn the user when detergent is low.

Steps for removal and installation of the detergent tank are as follows:

#### Removal:

1. Disconnect the two float switch wires at the quick connect electrical fittings.
2. Remove the 1/4-inch (6.35 mm) detergent line that enters the tank thru the screw on cap.
3. Lift out the detergent tank from the utility cabinet.
4. Unscrew the 63 mm cap from the tank; this will remove the float assembly.
5. Fill the tank with the approved detergent.

#### Install:

1. Install the 63 mm cap and float assembly into the detergent tank.
2. Lift the detergent tank back into the utility cabinet.
3. Install the 1/4-inch (6.35 mm) detergent line thru the hole in the 63 mm cap.
4. Connect the two float switch wires at the quick connect electrical fittings.

### Detergent Requirements

Detergent model X-701 manufactured by ZEP, Inc., is recommended by Accurex for use in the wash system. This product is biodegradable, non-caustic, and safe for kitchen staff to use. If X-701 detergent is not used, the cleanliness of the exhaust plenum and filters cannot be guaranteed.

#### NOTE

- X-701 is manufactured by ZEP, Inc., Atlanta, GA, USA. For details and ordering information, call 1-877-428-9937.
- If washed once a day, the 2.5 gallon detergent tank will last approximately 24 to 30 days depending on filter type.

### Preventative Maintenance

The following practices will prolong the life of the detergent pump:

- Keep detergent tank filled.
- Avoid spilling detergent on the exterior of the pump.
- Clean the detergent tank at least every six months.
- Clean the detergent line strainer at least every six months.
- Check tightness of all fittings periodically.

The detergent pump motor has sealed bearings which do not require lubrication.



# Electrical Connections

## NOTE

All wiring of electrical equipment must be done to meet NEC and local codes.

## NOTE

It is recommended that shielded wire be used for all low voltage connections (24V or less) to prevent signal interference with other high voltage circuits.

## NOTE

All 115 VAC field wiring (or higher) must be high temperature rated and must be routed through hard or flex conduit. All low voltage field wiring should be plenum rated if not routed through conduit. Field wiring should not come in contact with the surface of the hood. To reduce the likelihood of electromagnetic disturbance, avoid routing high and low voltage cables in the same conduit.

### Power for ASCP

- 115 VAC, power for controls (Terminals H and N)

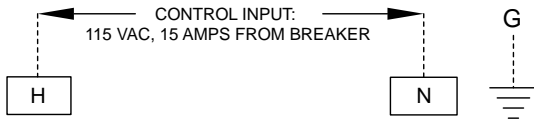

### Power for Lights - if equipped

- 115 VAC, power for hood lights, one per light circuit (Terminals H1, N1 | H2, N2 | H3, N3 | H4, N4)
- 115 VAC, power to lights, one per light circuit (Terminals B1, W1 | B2, W2 | B3, W3 | B4, W4)

EACH CANOPY LIGHTING CIRCUIT MUST NOT EXCEED 15A TOTAL CURRENT

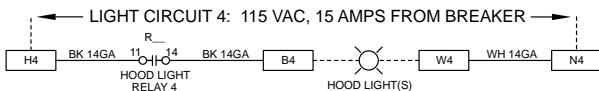
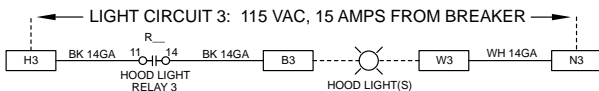
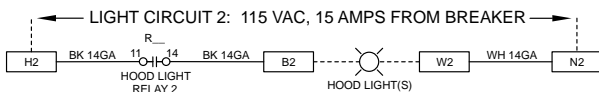
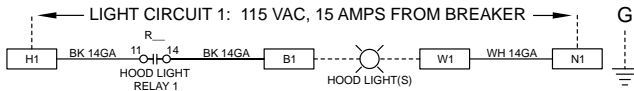

# Variable Frequency Drives (VFD) - if equipped

## NOTE

If electrically commutated motors are being used, VFDs will not be needed.

1. Bring power to the input of each VFD from a dedicated power source using conduit to the NEMA-1 enclosure on the bottom of the drive. Each power source shall be of the same voltage as the respective fan and of a high enough amp rating to handle the full load amp draw of the respective fan.

## NOTE

The VFD motor overload parameter (E2-01) needs to be set to match the motor nameplate FLA. Refer to the Quick Start Guide from Yaskawa (pages 83-89), or the Variable Frequency Drive information found on pages 32-33 for setting these parameters on the drive.

## NOTE

Be sure to use appropriately sized wire for the full load amp draw.

2. To avoid interference between the conductors, separate conduit from the VFD output to the input power of the fan must be used for each fan.

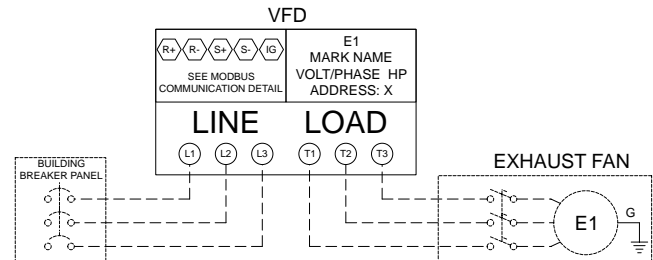

Each variable frequency drive must have the LINE and LOAD wiring in separate conduit.





**Vari-Green® Fan Wiring - if equipped**

**NOTE**

This wiring is only applicable with ASCP-V packages.

- 24 VAC from ASCP to Vari-Green motor control wire, black (Terminal E\_\_-24)
- 0-10 VDC Speed Reference from ASCP to Vari-Green motor control wire, red (Terminal E\_\_S+)
- Common from ASCP to Vari-Green motor control wire, white (Terminal E\_\_S-)

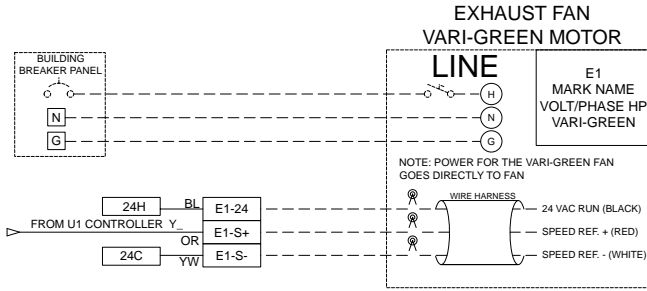

This is an example of Exhaust Fan 1 provided with Vari-Green motor.

**NOTE**

Some Vari-Green motors do not require the 24 VAC wire.

**VFD Provided by Others, Control Wiring - if equipped**

- Fault command from ASCP to VFD provided by others (Terminal E\_\_-FA, E\_\_-FB)
- Run command from ASCP to VFD provided by others (Terminal E\_\_-RA, E\_\_-RB)
- Speed reference from ASCP to VFD provided by others (Terminal E\_\_S+, E\_\_S-)
- Line power to VFD
- Load power from VFD to fan

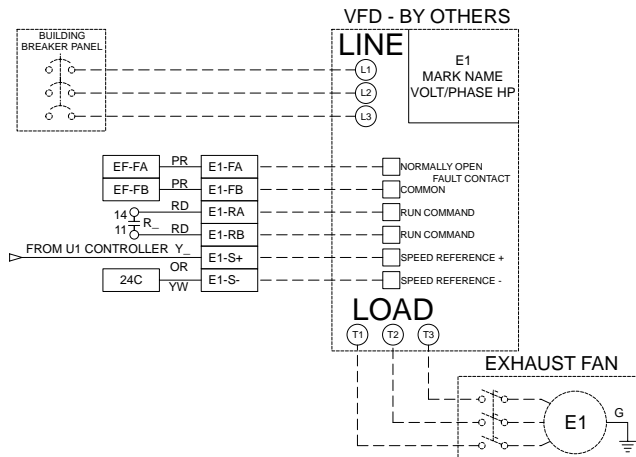

This is an example of Exhaust Fan 1 provided with a VFD by others.

**NOTE**

If the VFD by others is a supply fan, control terminals will begin with a 'S' instead of an 'E'.

**Make-Up Air VFD in ASCP Wiring - if equipped**

- 24 VAC run command from ASCP to make-up air unit (Terminals S\_\_-42, S\_\_-43)
- Tempering status from ASCP to make-up air unit (Terminals S\_\_-44, S\_\_-45)
- Line power to VFD input, bottom left of VFD (Terminals L1, L2, L3)
- Load power from VFD output, bottom right of VFD to make-up air disconnect (Terminals T1, T2, T3)

Make-up air unit requires separate 115 VAC or 3-phase control power circuit. See the MUA wiring diagram for details.

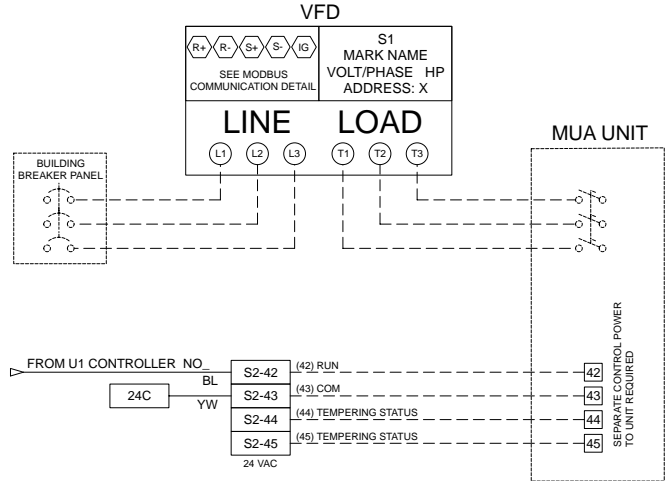

This is an example of Supply Fan 1 being a make-up air with VFD in the ASCP.

**Make-Up Air VFD in Make-Up Air Wiring - if equipped**

- 24 VAC run command from ASCP to make-up air unit (Terminals S\_\_-42, S\_\_-43)
- Tempering status from ASCP to make-up air unit (Terminals S\_\_-44, S\_\_-45)
- 0-10 VDC speed reference from ASCP to make-up air unit (Terminals S\_\_-46, S\_\_-47)

Power for make-up air goes directly to make-up air unit.

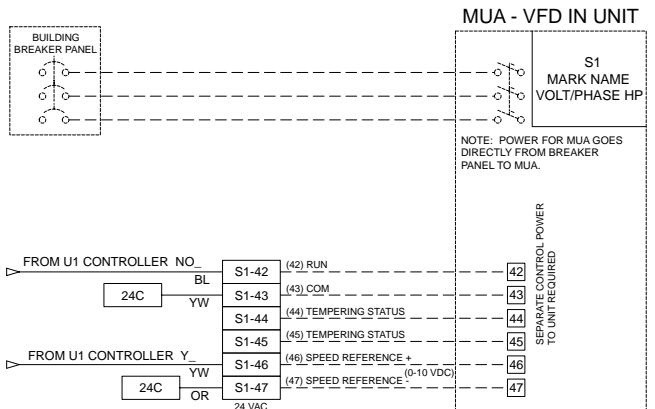

This is an example of Supply Fan 1 being a make-up air with VFD in the make-up air unit.



## Auto Tempering - if equipped

- Auto Heat/Cool enable  
(Terminals S1-R, S1-W1, S1-Y1)

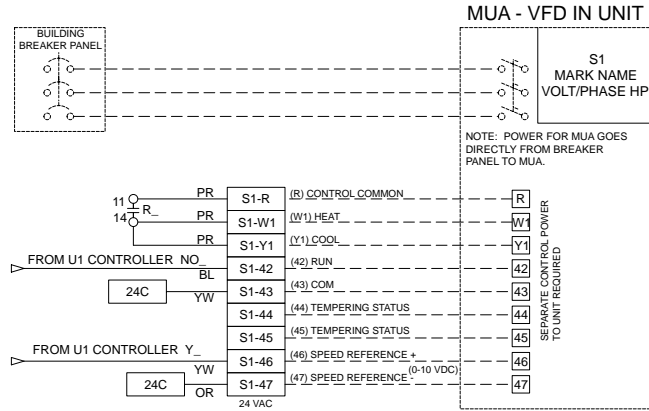

This is an example of Supply Fan 1 with auto tempering (VFD in make-up air unit).

## Fire System Microswitch

- Fire system microswitch common to ASCP  
(Terminal C1)
- Fire system microswitch normally closed contact to ASCP (Terminal NC1)

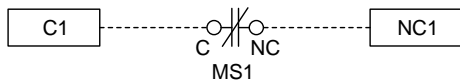

## Hood Solenoids and Temperature Sensor(s)

- if equipped

Each Auto Scrubber hood will include an 8x8x4 enclosure factory wired to the hood solenoids and sensors. If the Auto Scrubber Control Panel (ASCP) is not mounted on the hood, the field will need to wire from the 8x8x4 enclosure back to the ASCP. The hood sensors and solenoids are low voltage, therefore, 18 gauge stranded wire is recommended. The two wires of each hood sensor are not polarity sensitive.

The wiring diagram provided with the ASCP will display a table showing which sensors/solenoids connect to each hood. If more than one hood is being controlled, be sure that the appropriate sensor/solenoid is wired to the appropriate terminals as depicted on this diagram.

### Wash Hood Solenoids

- Wire between control panel terminal WO-\_A and hood j-box terminal WO-\_A
- Wire between control panel terminal WO-\_B and hood j-box terminal WO-\_B
- Wire between control panel terminal 24C and hood j-box terminal 24C
- Wire between control panel terminal GND and hood j-box terminal GND

### Wash Hood Temp Sensor 1 - if equipped

- Wire between control panel terminal T\_-A and hood j-box terminal T\_-A
- Wire between control panel terminal T\_-B and hood j-box terminal T\_-B

### Wash Hood Temp Sensor 2 - if equipped

- Wire between control panel terminal T\_-A and hood j-box terminal T\_-A
- Wire between control panel terminal T\_-B and hood j-box terminal T\_-B

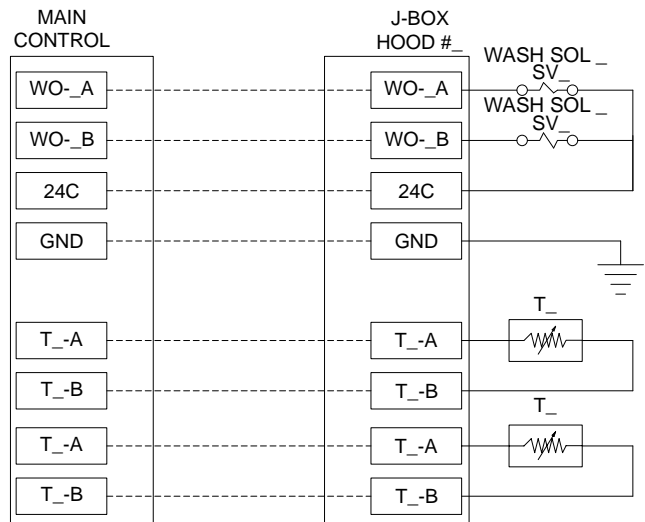

**Hood Solenoids and Temperature Sensor(s)**  
*- if equipped (continued)*

**CAUTION**

Each sensor is a low voltage, resistive temperature detector. They are not a high voltage switch/ thermostat. Do not connect temperature sensors in series/parallel with high voltage. This can result in damage to the temperature sensor and will require replacement.

**NOTE**

Each temperature sensor is rated up to 250°F (121.1°C), and therefore should not be exposed to direct flame. Exposing sensors to direct flame may render the sensor inoperable and replacements will not be covered under warranty.

**Keypad - if equipped**

- Connect provided cable from back of keypad to CAREL® PCO5+ controller (Terminal J10)

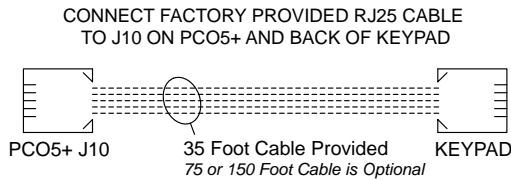

**Touch Screen - if equipped**

Power Wiring

- Connect provided 2-wire cable from ASCP (Terminals TS24, TSC) to touch screen (Terminals G, GO)

Control Wiring

- Connect provided 3-wire cable from ASCP (Terminals -, +, GND) to touch screen (Terminals -, +, GND)

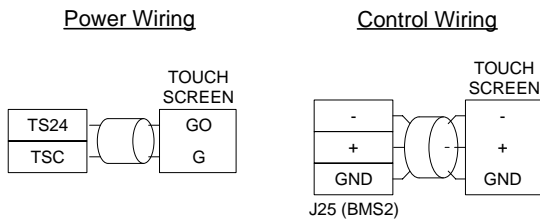

**Remote Enable - if equipped**

- Connect remote enable common and normally open from BMS to ASCP (Terminals RE-1A, RE-1B)  
 A closed contact will turn on all fans.  
 An open contact will turn off all fans.

**NOTE**

Temperature interlock will override the remote enable input.

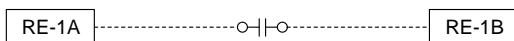

**Shunt Trip - if equipped**

- 115 VAC from ASCP to shunt trip breaker coil (provided by others) (Terminals STH, STN)  
 Voltage across STH, STN when in fire will be 115 VAC  
 Voltage across STH, STN when not in fire will be 0 VAC



**NOTE**

Shunt trip contacts will lose voltage during momentary losses in power to the ASCP, tripping the connected shunt trip breaker. If installed in areas with frequent losses in power, it is recommended that all shunt trip breakers be wired through a normally open (N.O.) contact of an additional fire system microswitch instead.

**Electric Gas Valve with Gas Reset - if equipped**

- 115 VAC from ASCP to gas solenoid (Terminals SVH, SVN)  
 Voltage across SVH, SVN when in fire will be 0 VAC  
 Voltage across SVH, SVN when not in fire and turn on will be 115 VAC

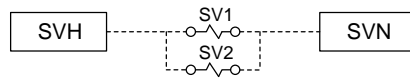

**Spare Fire Relay Contacts - if equipped**

- Power to common (Terminal C3)
- Power out, normally open, closed in fire (Terminal NO3)
- Power out, normally closed, open in fire (Terminal NC3)
- Power to common (Terminal C4)
- Power out, normally open, closed in fire (Terminal NO4)
- Power out, normally closed, open in fire (Terminal NC4)

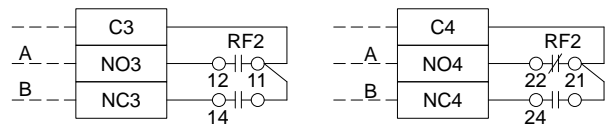

- A < OPEN WITH POWER AT H & N & FIRE SYSTEM ARMED  
 CLOSED ON FIRE OR NO POWER
- B < CLOSED WITH POWER AT H & N & FIRE SYSTEM ARMED  
 OPEN ON FIRE OR NO POWER



**Grease Trapper Pollution Control Unit (PCU) Filter Status - if equipped**

- PCU filter 24 VAC hot from terminal FH in enclosure on the access side of the unit to ASCP (Terminal FH)
- PCU filter 1 module status from terminal F1 in enclosure on access side of the unit to ASCP (Terminal F1)
- PCU filter 2 module status from terminal F2 in enclosure on access side of the unit to ASCP (Terminal F2)
- PCU filter 3 module status from terminal F3 in enclosure on access side of the unit to ASCP (Terminal F3)

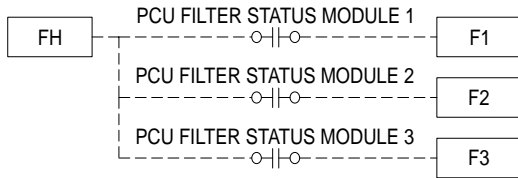

**Airflow Proving Switch(es) (provided by others) - if equipped**

- Common and normally open from supply fan 1 air proving switch to ASCP (Terminals AP-1A, AP-1B)
- Common and normally open from supply fan 2 air proving switch to ASCP (Terminals AP-2A, AP-2B)
- Common and normally open from supply fan 3 air proving switch to ASCP (Terminals AP-3A, AP-3B)
- Common and normally open from supply fan 4 air proving switch to ASCP (Terminals AP-4A, AP-4B)

**NOTE**  
Air proving switch(es) are not provided with the ASCP

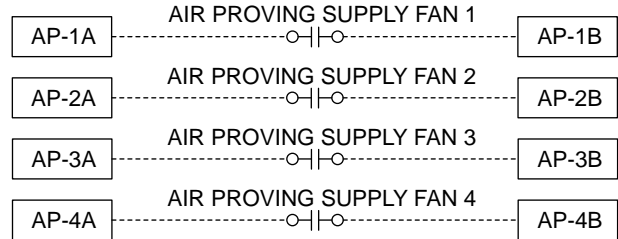

**High Temperature Alarm Contacts - if equipped**

- Power to common (Terminal HT-C)
- Power out, normally closed, open in high temperature alarm (Terminal HT-NC)
- Power out, normally open, closed in high temperature alarm (Terminal HT-NO)

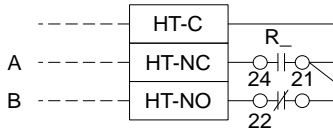

- A < CLOSED WITH POWER AT H & N & HIGH TEMP ALARM INACTIVE, CLOSED WITH NO POWER
- B < CLOSED WITH POWER AT H & N & FIRE SYSTEM ARMED, OPEN ON FIRE OR NO POWER



## System Wash Contacts

- Power to common (Terminal C5)
- Power out, normally open, closed when wash active (Terminal NO5)
- Power out, normally closed, open when wash active (Terminal NC5)
- Power to common (Terminal C6)
- Power out, normally open, closed when wash active (Terminal NO6)
- Power out, normally closed, open when wash active (Terminal NC6)



- A < CLOSED WITH POWER AT H & N & WASH HOOD ACTIVE, OPEN WITH NO POWER
- B < OPEN WITH POWER AT H & N & WASH HOOD INACTIVE, CLOSED WITH NO POWER

## System Fan Contacts – if equipped

These terminals will only be available with the ASCP-W configuration (Auto Scrubber Control Panel with Wash Only Control). These terminals can be utilized by external panels that are controlling fans to know when fans need to run during the dry sequence of a wash cycle.

- Power to common (Terminal C7)
- Power out, normally open, closed when fans should run (Terminal NO7)
- Power out, normally closed, open when fans should run (Terminal NC7)
- Power to common (Terminal C8)
- Power out, normally open, closed when fans should run (Terminal NO8)
- Power out, normally closed, open when fans should run (Terminal NC8)

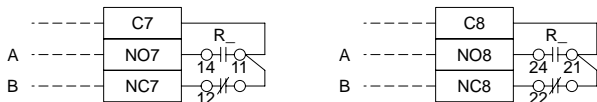

- A < CLOSED WITH POWER AT H & N & FAN ACTIVE, OPEN WITH NO POWER
- B < OPEN WITH POWER AT H & N & FAN INACTIVE, CLOSED WITH NO POWER

## Exhaust/Supply Fan Contacts – if equipped

These terminals will only be available with the ASCP-B configuration (Auto Scrubber Basic On/Off Fan Controls – Fan Starters/VFDs by Others). These terminals can be utilized to engage/disengage externally-provided fan starter(s) or VFD(s).

- Power to common (Terminal C7)
- Power out, normally open, closed when exhaust fan(s) should run (Terminal NO7)
- Power out, normally closed, open when exhaust fan(s) should run (Terminal NC7)
- Power to common (Terminal C8)
- Power out, normally open, closed when exhaust fan(s) should run (Terminal NO8)
- Power out, normally closed, open when exhaust fan(s) should run (Terminal NC8)
- Power to common (Terminal C11)
- Power out, normally open, closed when supply fan(s) should run (Terminal NO11)
- Power out, normally closed, open when supply fan(s) should run (Terminal NC11)
- Power to common (Terminal C12)
- Power out, normally open, closed when supply fan(s) should run (Terminal NO12)
- Power out, normally closed, open when supply fan(s) should run (Terminal NC12)

### SYSTEM EXHAUST FAN CONTACTS - MELINK, BMS, OTHER

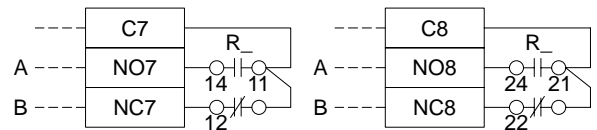

- A < CLOSED WITH POWER AT H & N & FAN ACTIVE, OPEN WITH NO POWER
- B < OPEN WITH POWER AT H & N & FAN INACTIVE, CLOSED WITH NO POWER

### SYSTEM SUPPLY FAN CONTACTS - MELINK, BMS, OTHER

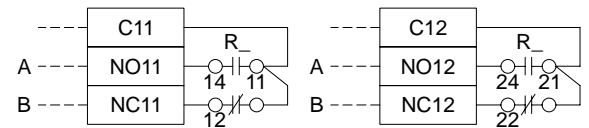

- A < CLOSED WITH POWER AT H & N & FAN ACTIVE, OPEN WITH NO POWER
- B < OPEN WITH POWER AT H & N & FAN INACTIVE, CLOSED WITH NO POWER

## Fan Input – if equipped

- On the ASCP-W configuration, this input will stop a wash if closed (Terminals RE-1A and RE-1B)

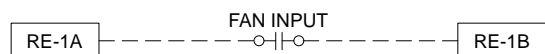

**Wash Input – if equipped**

- If the panel is configured to start a wash through a digital input, this input will, if closed, initiate a wash cycle.

**NOTE**

If this input opens at any point during the wash cycle, the wash cycle will be aborted.

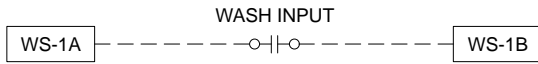

**Duct Sump Solenoids – if equipped**

If the panel was configured to control duct sumps, each will be provided (shipped loose) with a 3/4-inch solenoid valve. Each valve will need to be wired back to the ASCP panel. Solenoids are 24 VAC (use 18 gauge, stranded wire).

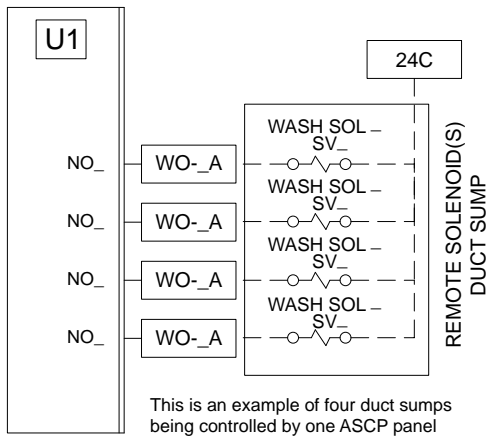

**Power for Starters and Fans – if equipped**

**NOTE**

This wiring is only applicable with ASCP-K packages.

The ASCP-K package is equipped with contactors that may have thermal overloads attached to them. The breaker size (amps), wire gauge, phase, and voltage for each fan is specified on the wiring diagram.

**115 VAC Single Phase Fan(s) Power Wiring**

- LINE – from breaker to terminal blocks E/S\_-L1 and E/S\_-L2
- LOAD – from terminal T3 on bottom of starter and terminal block E/S\_-L2 to fan disconnect

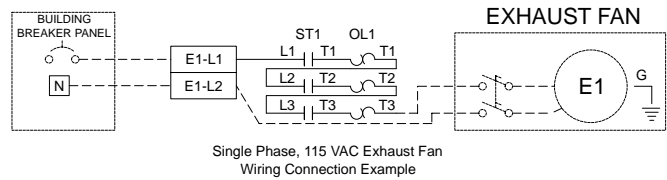

**200/208/230/277 VAC Single Phase Fan(s) Power Wiring**

- LINE – from breaker to terminal blocks E/S\_-L1 and E/S\_-L2
- LOAD – from terminals T1 and T3 on bottom of starter to fan disconnect

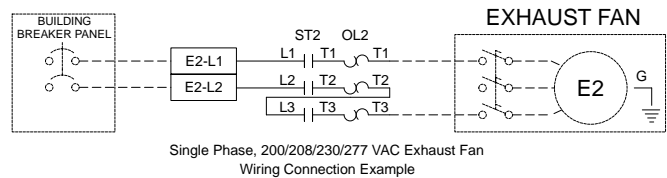

**Three Phase Fan(s) Power Wiring**

- LINE – from breaker to terminal blocks E/S\_-L1, E/S\_-L2, and E/S\_-L3
- LOAD – from terminals T1, T2, T3 on bottom of starter to fan disconnect

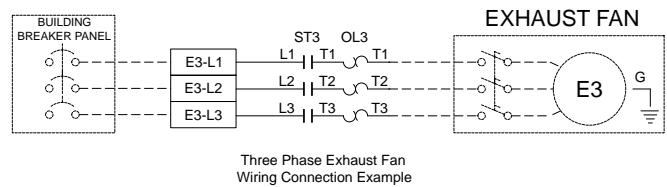

# ASCP Connection Checklist

## Power for ASCP

- Connect 115 VAC power for controls (Terminals H, N)
- Connect 115 VAC power for hood lights, one per light circuit (Terminals H1, N1 | H2, N2 | H3, N3 | H4, N4)
- Connect 115 VAC power to lights, one per light circuit (Terminals B1, W1 | B2, W2 | B3, W3 | B4, W4)

## Power to Variable Frequency Drives (VFD)\*

- Line power to VFD input, bottom left of VFD (Terminals L1, L2, L3)
- Load power from VFD output, bottom right of VFD (Terminals T1, T2, T3)

## Vari-Green® Fan Wiring\* - if equipped

- 24 VAC from ASCP to Vari-Green motor control wire, black (Terminal E\_\_-24)  
*Not required on 2 HP Vari-Green motors*
- 0-10 VDC Speed Reference from ASCP to Vari-Green motor control wire, red (Terminal E\_\_S+)
- Common from ASCP to Vari-Green motor control wire, white (Terminal E\_\_S-)

## VFD Provided by Others, Control Wiring\* - if equipped

- Fault command from ASCP to VFD provided by others (Terminal E\_\_-FA, E\_\_-FB)
- Run command from ASCP to VFD provided by others (Terminal E\_\_-RA, E\_\_-RB)
- Speed reference from ASCP to VFD provided by others (Terminal E\_\_S+, E\_\_S-)
- Line power to VFD
- Load power from VFD to fan

## Make-Up Air VFD in ASCP Wiring\* - if equipped

- 24 VAC run command from ASCP to make-up air unit (Terminals S\_\_-42, S\_\_-43)
- Tempering status from ASCP to make-up air unit (Terminals S\_\_-44, S\_\_-45)
- Line power to VFD input, bottom left of VFD (Terminals L1, L2, L3)
- Load power from VFD output, bottom right of VFD to make-up air disconnect (Terminals T1, T2, T3)

## Make-Up Air VFD in Make-Up Air Wiring\* - if equipped

- 24 VAC run command from ASCP to make-up air unit (Terminals S\_\_-42, S\_\_-43)
- Tempering status from ASCP to make-up air unit (Terminals S\_\_-44, S\_\_-45)
- 0-10 VDC speed reference from ASCP to make-up air unit (Terminals S\_\_-46, S\_\_-47)

**\*Wiring repeated based on the number of fans and hoods of that type. This is based on the job specific ASCP wiring diagram.**

## Auto Tempering - if equipped

- Auto Heat/Cool enable (Terminals S1-R, S1-W1, S1-Y1)

## Fire System Microswitch

- Fire system microswitch common to ASCP (Terminal C1)
- Fire system microswitch normally closed contact to ASCP (Terminal NC1)

## Hood Solenoids and Temperature Sensors - if equipped

- Wash Hood Solenoids (Terminals WO-\_A, WO-\_B, 24C, GND in control panel to corresponding terminals in hood j-box)
- Wash hood temp sensor 1 (T\_-A and T\_-B in control panel to corresponding terminals in hood j-box)
- Wash hood temp sensor 2 (T\_-A and T\_-B in control panel to corresponding terminals in hood j-box)

## Keypad - if equipped

- Connect provided RJ25 cable from back of keypad to CAREL® PCO5+ (Terminal J10)

## Touch Screen - if equipped

- Connect provided 2-wire cable from ASCP (Terminals TS24, TSC) to touch screen (Terminals G, GO)
- Connect provided 3-wire cable from ASCP (Terminals -, +, GND) to touch screen (Terminals -, +, GND)

## Remote Enable- if used

- Connect remote enable common and normally open from BMS to ASCP (Terminals RE-1A, RE-1B)

## Shunt Trip - if used

- 115 VAC from ASCP to shunt trip breaker coil (provided by others) (Terminals STH, STN)

## Electric Gas Valve with Gas Reset - if equipped

- 115 VAC from ASCP to gas solenoid (Terminals SVH, SVN)

## Spare Fire Relay Contacts - if equipped

- Power to common (Terminal C3)
- Power out, normally open, closed in fire (Terminal NO3)
- Power out, normally closed, open in fire (Terminal NC3)
- Power to common (Terminal C4)
- Power out, normally open, closed in fire (Terminal NO4)
- Power out, normally closed, open in fire (Terminal NC4)

## Grease Trapper Pollution Control Unit (PCU)

### Filter Status - if equipped

- PCU filter status 24 VAC hot (FH)
- PCU filter 1 module status (F1)
- PCU filter 2 module status (F2)
- PCU filter 3 module status (F3)

### High Temperature Alarm Contacts - if equipped

- Power to common (Terminals HT-C)
- Power out, normally closed, open in high temperature alarm (Terminal HT-NC)
- Power out, normally open, closed in high temperature alarm (Terminal HT-NO)

### Air Proving Switch(es) (provided by others) - if equipped

- Common and normally open from supply fan 1 air proving switch to ASCP (Terminals AP-1A, AP-1B)
- Common and normally open from supply fan 2 air proving switch to ASCP (Terminals AP-2A, AP-2B)
- Common and normally open from supply fan 3 air proving switch to ASCP (Terminals AP-3A, AP-3B)
- Common and normally open from supply fan 4 air proving switch to ASCP (Terminals AP-4A, AP-4B)



## ASCP Connection Checklist- *continued*

---

### **System Wash Contacts**

- Power to common (Terminal C5)
- Power out, normally open, closed when wash active (Terminal NO5)
- Power out, normally closed, open when wash active (Terminal NC5)
  
- Power to common (Terminal C6)
- Power out, normally open, closed when wash active (Terminal NO6)
- Power out, normally closed, open when wash active (Terminal NC6)

### **System Fan Contacts – if equipped**

- Power to common (Terminal C7)
- Power out, normally open, closed when fans should run (Terminal NO7)
- Power out, normally closed, open when fans should run (Terminal NC7)
  
- Power to common (Terminal C8)
- Power out, normally open, closed when fans should run (Terminal NO8)
- Power out, normally closed, open when fans should run (Terminal NC8)

### **Exhaust/Supply Fan Contacts – if equipped**

- Power to common (Terminal C7)
- Power out, normally open, closed when exhaust fan(s) should run (Terminal NO7)
- Power out, normally closed, open when exhaust fan(s) should run (Terminal NC7)
  
- Power to common (Terminal C8)
- Power out, normally open, closed when exhaust fan(s) should run (Terminal NO8)
- Power out, normally closed, open when exhaust fan(s) should run (Terminal NC8)
  
- Power to common (Terminal C11)
- Power out, normally open, closed when supply fan(s) should run (Terminal NO11)
- Power out, normally closed, open when supply fan(s) should run (Terminal NC11)
  
- Power to common (Terminal C12)
- Power out, normally open, closed when supply fan(s) should run (Terminal NO12)
- Power out, normally closed, open when supply fan(s) should run (Terminal NC12)

### **Fan Input – if equipped**

- Fan input, stops wash if closed (Terminals RE-1A and RE-1B)

### **Wash Input – if equipped**

- Wash input, enables wash if closed (Terminals WS-1A and WS-1B)

### **Duct Sump Solenoids – if equipped**

- 24 VAC power to each solenoid (Terminals WO-\_A and 24C)

### **Power for Starters and Fans – if equipped**

- LINE for 115/1 from breaker (Terminals E/S\_-L1 and E/S\_-L2)
- LOAD for 115/1 to fan (Terminal T3 on starter and terminal block E/S\_-L2)
  
- LINE for 200-208-230-277/1 from breaker (Terminals E/S\_-L1 and E/S\_-L2)
- LOAD for 200-208-230-277/1 to fan (Terminals T1 and T3 on starter)
  
- LINE for 3-phase fans from breaker (Terminals E/S\_-L1, E/S\_-L2, E/S\_-L3)
- LOAD for 3-phase fans to fan (Terminals T1, T2, T3 on starter)





# Typical Electrical Connection Layout

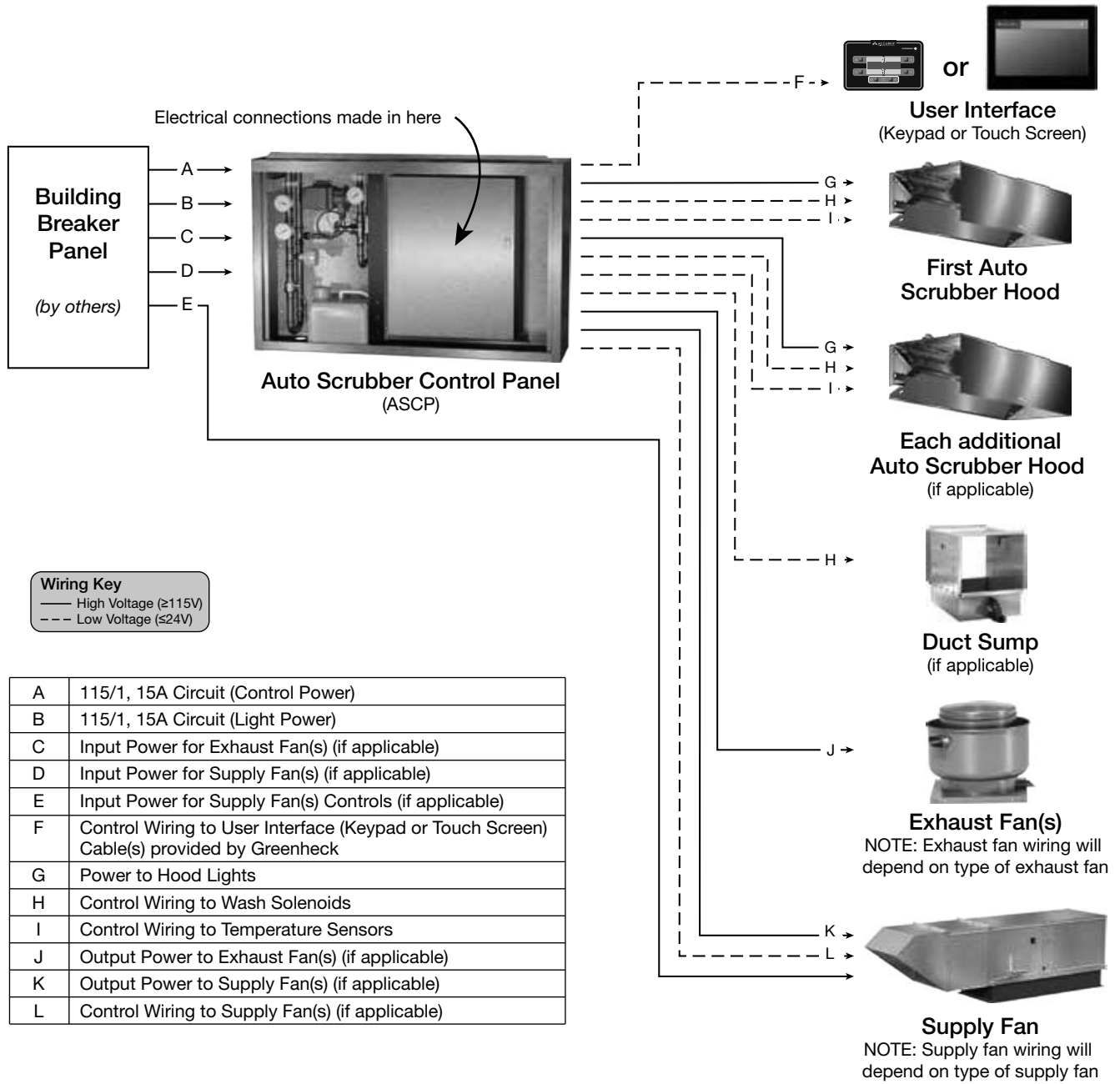

## Sequence of Operation - ASCP-W

---

### Normal Operation

1. Press the WASH button on the keypad or WASH ON/OFF button on the touch screen to start a wash.
  - a. Wash will start with either the first hood or first sump, and when completed, proceed to wash the next hood/sump in the sequence.
  - b. See "Wash Operation" section for additional details on what can prematurely stop a hood wash (or prevent a hood from washing).
2. Press the WASH button on the keypad or the WASH ON/OFF button on the touch screen again to stop a wash from being completed.
3. If equipped, pressing the ALL LIGHTS button on the keypad or the ALL LIGHTS ON/OFF button on the touch screen will turn on all the hood lights.
4. If equipped, pressing the ALL LIGHTS button on the keypad or the ALL LIGHTS ON/OFF button on the touch screen again will turn off all the hood lights.
5. If equipped, pressing the GAS RESET button on the keypad (or GAS RESET ON/OFF button on the touch screen) will open the electric gas valve to allow gas to flow to the appliances. Once gas has been reset, it cannot be manually shut off by this button. It will remain enabled until an alarm condition such as a high temperature or fire is detected, or the control panel power is reset.

### WARNING

Make sure after opening the electric gas valve that all pilot lights (if appliances have standing pilots) are lit. Failing to relight pilots will cause gas to flow into the kitchen.



## Sequence of Operation - ASCP-B and ASCP-K

### Normal Operation

1. Press the ALL HOODS button on the keypad or the ALL HOODS ON/OFF button on the touch screen to turn the fans on (manual mode).
  - a. ASCP will engage all exhaust/supply fans.
  - b. If the keypad was configured for individual fan/light control, pressing the HOODS button (or INDIVIDUAL HOOD SYSTEM ON/OFF button on the touch screen) will navigate to screens where individual hood system control will be available.
2. Press the ALL HOODS button on the keypad or the ALL HOODS ON/OFF button on the touch screen to turn off the fans.
  - a. Only if all the fans are on will pressing the ALL HOODS or ALL HOODS ON/OFF button shut off all of the fans.
  - b. The ASCP may go into auto mode if conditions 3.a -3.c are met.
3. Temperature interlock mode (auto mode) – if applicable
  - a. If the temperature in the hood goes above the temperature interlock on setpoint (115°F default) and the fans are currently off, the ASCP will automatically turn on the associated exhaust and/or supply fans.
  - b. If the temperature in the hood goes below the temperature interlock off setpoint (90°F default) and the fans are not currently turned on manually, the fan(s) will turn off after the temperature interlock off delay time setpoint (10 minutes default).
  - c. If the fans were turned on manually and the user attempts to turn off the fans with the hood temperature not meeting condition b, the fan(s) will remain on until such conditions are met.
4. Press the WASH button on the keypad or WASH ON/OFF button on the touch screen to start a wash.
  - a. Wash will start with either the first hood or first sump, and when completed proceed to wash the next hood/sump in the sequence.
  - b. See “Wash Operation” section for additional details on what can prematurely stop a hood wash (or prevent a hood from washing)
5. Press the WASH button on the keypad or the WASH ON/OFF button on the touch screen again to stop a wash from being completed.
6. If equipped, pressing the ALL LIGHTS button on the keypad or the ALL LIGHTS ON/OFF button on the touch screen will turn on all the hood lights.
  - a. If the keypad was configured for individual fan/light control, pressing the LIGHTS button (or INDIVIDUAL LIGHT ON/OFF button on the touch screen) will navigate to screens where individual light circuit control will be available.
7. If equipped, pressing the ALL LIGHTS button on the keypad or the ALL LIGHTS ON/OFF button on the touch screen again will turn off all the hood lights.
  - a. Only if all of the hood lights are currently on will pressing the LIGHTS or ALL LIGHTS ON/OFF button shut off all of the hood light circuits.
8. If equipped, on the keypad, pressing the MORE button will navigate to additional screens. Pressing the BACK button will navigate back to the previous screen.
9. If equipped, pressing the GAS RESET button on the keypad (or GAS RESET ON/OFF button on the touch screen) will open the electric gas valve to allow gas to flow to the appliances. Once gas has been reset, it cannot be manually shut off by this button. It will remain enabled until an alarm condition such as a high temperature or fire is detected, or the control panel power is reset.
10. If equipped, pressing the AUTO TEMP button on the keypad (or AUTO TEMPERING ON/OFF button on the touch screen) will enable automatic tempering of the MUA unit. When this is on, the make-up air will heat/cool the air as determined by the inlet air sensors. When this is off, the make-up air heating/cooling will be disabled.

### WARNING

Make sure after opening the electric gas valve that all pilot lights (if appliances have standing pilots) are lit. Failing to relight pilots will cause gas to flow into the kitchen.



## Sequence of Operation - ASCP-V

### Normal Operation

1. Press the ALL HOODS button on the keypad or the ALL HOODS ON/OFF button on the touch screen to turn the fans on (manual mode).
  - a. ASCP will turn on all exhaust and supply fans.
  - b. The ASCP system starts the fans at idle speeds between the low speed set point (50% default) and high speed set point (100% default) based on actual cooking loads as sensed by the temperature sensors mounted in the hood capture area. This is determined by the low temperature set point (90°F default) and high temperature set point (115°F default).
  - c. The ASCP system adjusts the supply speed based on a weighted average of the exhaust fan speed. If static pressure sensor is used for supply airflow control it will adjust the supply speed based on static pressure.
  - d. If the keypad was configured for individual fan/light control, pressing the HOODS button (or INDIVIDUAL HOOD SYSTEM ON/OFF button on the touch screen) will navigate to screens where individual hood system control will be available.
2. Press the ALL HOODS button on the keypad or the ALL HOODS ON/OFF button on the touch screen again to turn off the fans.
  - a. Only if all of the fans are on will pressing the ALL HOODS or ALL HOODS ON/OFF button shut off all of the fans.
  - b. The ASCP system may go into auto mode if conditions 3.a-3.c are met.
3. Temperature interlock mode (auto mode).
  - a. If the temperature in the hood goes above the temperature interlock on set point (115°F default) and the fans are currently off, the ASCP will automatically turn on the associated exhaust and/or supply fans.
  - b. If the temperature in the hood goes below the temperature interlock off set point (90°F default) and the fans are not currently turned on manually the fans will turn off after the temperature interlock off delay time set point (10 minute default).
  - c. If the fans were turned on manually and the user attempts to turn off the fans with the hood temperature not meeting condition b the fan(s) will remain on until such conditions are met.
4. With the fan(s) on via manual or auto mode, pressing the FAN 100% button on the keypad (100% OVERRIDE ON/OFF button on the touch screen) will force the exhaust fan(s) that are currently on to full speed for the 100% override off delay set point. The supply fan will adjust speed the same as 1.c.
5. Pressing the FAN 100% button on the keypad (100% OVERRIDE ON/OFF button on the touch screen) will turn the 100% override off and return the fans to the speed as discussed in 1.b.
6. Pressing the ALL LIGHTS button on the keypad or the ALL LIGHTS ON/OFF on the touch screen will turn on all the hood lights.
  - a. If the keypad was configured for individual fan/light control, pressing the LIGHTS button (or INDIVIDUAL LIGHT ON/OFF button on the touch screen) will navigate to screens where individual light circuit control will be available.
7. Pressing the LIGHTS button on the keypad or ALL LIGHTS ON/OFF button on the touch screen again will turn off all of the hood lights.
  - a. Only if all the hood lights are currently on will pressing the LIGHTS or ALL LIGHTS ON/OFF button shut off all of the hood light circuits.
8. If equipped, on the keypad, pressing the MORE button will navigate to additional screens. Pressing the BACK button will navigate back to the previous screen.
9. If equipped, pressing the GAS RESET button on the keypad (or GAS RESET ON/OFF button on the touch screen) will open the electric gas valve to allow gas to flow to the appliances. Once gas has been reset, it cannot be manually shut off by this button. It will remain enabled until an alarm condition such as high temperature or fire is detected, or the control panel power is reset.

### WARNING

Make sure after opening the electric gas valve that all pilot lights (if appliances have standing pilots) are lit. Failing to relight pilots will cause gas to flow into the kitchen.

10. If equipped, pressing the AUTO TEMP button on the keypad (or AUTO TEMPERING ON/OFF button on the touch screen) will enable automatic tempering of the MUA unit. When this is on, the make-up air will heat/cool the air as determined by the inlet air sensors. When this is off, the make-up air heating/cooling will be disabled.



## Sequence of Operation - Fire and Alarm Operation

---

### Fire Operation:

1. With the fire system microswitch wired to terminal C1 and NC1 (normally-closed contact) and the fire system in a fire state, the following will occur:
  - a. System alarm will appear on keypad or touch screen.
  - b. ASCP will stop any wash cycle currently in progress.
  - c. *If ASCP-V panel*, ASCP will force the exhaust fan(s) to full speed. *If ASCP-W, ASCP-B, or ASCP-K panel*, ASCP will turn on exhaust fans (factory default, but can be adjusted in the service menu).
  - d. *If ASCP-V or ASCP-K panel*, ASCP will force the supply fans off. (Factory default, but can be adjusted in the service menu).
  - e. ASCP will send 115 VAC signal to shunt trip breaker coil (breaker provided by others).
  - f. *If equipped with lights*, ASCP will force the lights off (if selected with the lights out in fire option).
  - g. *If equipped with gas reset*, ASCP will force the electric gas valve off.

### Alarm Operation:

Upon any system alarm, the red system fault LED will flash on the keypad (red alarm indicator will flash on the touch screen). Once the alarm is corrected, the LED/indicator will stop flashing. A list of possible alarms is shown below:

1. Kitchen fire alarm
2. Temperature sensor fault - *if equipped*.
  - a. Associated fan(s) will be turned on and forced to full speed until fault is rectified.
3. Exhaust or supply VFD alarm - *if equipped*.
4. Supply airflow proving fault - *if equipped*.
  - a. Exhaust fans will not turn on until supply airflow has been proven. It will remain this way until the fault is rectified.
5. Pressure sensor fault - *if equipped*.
  - a. Supply fan speed will automatically be controlled via weighted average until the fault is rectified.
6. High temperature alarm - *if equipped*.
  - a. ASCP will send 115 VAC signal to shunt trip breaker coil (breaker provided by others).
  - b. ASCP will force the electric gas valve off (if selected with gas valve reset option).
7. PCU filter status alarm - *if equipped*.
8. Low detergent detected

### NOTE

When initially triggered, all alarms will be logged into the alarm logger on the controller.

## System Optimization - ASCP-V Panel Only

---

### Setting the Low Temperature Set Point (90°F default)

**NOTE:** If the system is provided with a keypad, press the Prg button (⊙) for 5 seconds to enter the main menu.

1. Go to the Service menu. Press Enter button.
2. Go to the Setpoints menu. Press Enter button.
3. Insert service password (default 1000).
4. Press down until you find the Exhaust Fan Setpoints.
5. Current temp that is controlling that fan will be displayed at the bottom of the screen. Adjust the Low Temp to be 5 - 10 degrees above this temperature.

### Setting the High Temperature Set Point (115°F default)

1. Turn the fans on via the keypad or touchscreen.
2. Turn on all cooking appliances (on highest setting) and allow them to reach normal cooking temperatures.
3. Go to the Service menu. Press Enter button.
4. Go to the Setpoints menu. Press Enter button.
5. Insert service password (default 1000).
6. Press down until you find the Exhaust Fan Setpoints.
7. Current temp that is controlling that fan will be displayed at the bottom of the screen. Adjust the High Temp to be 5 - 10 degrees below this temperature.





# Controller Setup and Tutorial







The user can access the main menu by pressing the  button.

Within the programmable logic controller, factory set points can be modified to configure the system for specific functions if necessary. All parameters are shown in this section.

Some of the menus require the user to enter a password in order to enter the menu. The service password is 1000 and is entered by pressing the   and  buttons.

The DDC controller is located in the unit control panel. The face of the controller has six buttons, allowing the

user to view unit conditions and alter parameters. The DDC controller is pre-programmed with easy to use menus.

To change the display contrast, hold the Alarm  and Program  buttons simultaneously while pressing the  and  arrows.





If equipped, the keypad user interface connects via a factory-provided RJ-25 cable to the J10 port on the controller.

Information regarding most of the settings within the Controller U1 are provided in this Installation, Operation and Maintenance Manual.

## NOTE

Depending on the configuration (ASCP-W, B, K, V) and options selected, certain menus may not be available.

## Keypad Navigation



	Escape	Allows the user to exit the current menu.
	Up   Down	The arrow buttons allow the user to scroll through different screens and adjust parameters.
	Alarm	Button will blink red, indicating an alarm condition. Press to review current alarms. To review previous alarms, access the DATA LOGGER in the alarm menu.
	Enter	A. In screens with adjustable parameters, pressing the Enter button moves the cursor from the upper left corner of the screen to the parameter. The arrow buttons can then be used to adjust the parameter. B. To move to the next parameter on the same screen, press the Enter button. C. To save the change, press the Enter button until the cursor moves back to the <b>upper left corner</b> of the screen.
	Program	Pressing the Program button allows the user to enter the Main Program Menu.

## Example of Parameter Adjustment

Exhaust 1 Setpoints		
	Temp	Speed
Low:	90.0°F	50.0%
High:	115.0°F	100.0%
Current Temp:	70.0°F	

Once you enter into a menu that has adjustable parameters, the cursor always begins in the upper left corner of the display and will be blinking. Press the  button to move the cursor down for parameter adjustment.

Exhaust 1 Setpoints		
	Temp	Speed
Low:	<u>90.0°F</u>	50.0%
High:	115.0°F	100.0%
Current Temp:	70.0°F	

Once the cursor has reached the desired parameter, press the   buttons to adjust the value.

Exhaust 1 Setpoints		
	Temp	Speed
Low:	90.0°F	50.0%
High:	115.0°F	100.0%
Current Temp:	70.0°F	

When satisfied with the adjustment, press the  button to save the parameter. **When finished, make certain the cursor is in the upper left corner. If the cursor is not in the upper left corner, the changes will not be saved.** The cursor must be in the upper left corner to enable screen advancement.



## Hood/System Status

If the ASCP panel is configured with a touch screen, the controller will revert back to either a kitchen hood status loop (if controlling fans) or a system status screen (if not controlling fans). This loop includes several screens to view the operating conditions of the unit. If configured, scroll through the menu screens by using the ↑ and ↓ buttons. **Screens with a dashed line border are dependent upon the configuration and may not appear for every system.**

TIME	DATE	UNIT##
Kitchen Hood 1		Speed
XXX°F		XXX%
Hood System 1		
Status: OFF		
*No Supply Airflow		

### ***KITCHEN HOOD #1 STATUS:***

The temperature on this screen displays real-time conditions from the sensors located in the hood. The speed on this screen displays the real-time conditions of the fans exhausting this hood.

“Hood System 1” describes the hood system that this particular hood is part of; hoods that are exhausted from the same exhaust fan will be linked to a hood “system”.

The “Status” indicator will display the following hood statuses:

- ON: Hood has been turned on; fans controlling the hood are operational.
- ON by Temp: Hood has been turned on by temperature interlock/high temperatures in the hood.
- ON by Alarm: Hood has been turned on due to an alarm.
- OFF: Hood is off; fans controlling the hood are not running.
- FIRE: Kitchen fire has been detected under one of the hoods.

If the airflow proving option is included, the hoods have been turned on, and supply airflow is not detected, “No Supply Airflow” will be displayed on the screen (see example).

TIME	DATE	UNIT##
FANS OFF		
AS Hood 1 Washing		
No Sumps Washing		
H1 SEQ1 TIME LEFT:		110s
DET TIME LEFT:		42s

### ***SYSTEM STATUS:***

When configured as ASCP-W, this screen shows what hoods/sumps are washing and the status of the wash cycle if currently in a wash (see example).





## Example of Alarms

If an alarm occurs, the  button will flash red on the controller and the keypad (if connected).

**Alarms**

Press DOWN to review current alarm(s).  
Press ESC to exit.  
Press ALARM to reset.

To navigate to the alarm menu, press the  button once. Press the  button to scroll through any current alarms. Once the problem causing the alarm has been corrected, the alarm will automatically clear. If the alarm cannot be cleared, the cause of the alarm has not been fixed.

**\*\*\* ALARM \*\*\***

Temp Sensor Input 1  
Failure

Confirm sensor is connected to terminals T1-A & T1B.

This is an example of a hood temperature sensor failure.

**Alarms**

No active alarm



Press ENTER key to access ALARM HISTORY log.

This screen appears if there are no active alarms.



To view all saved alarms, press the  button to enter the DATA LOGGER. For more information, see the Data Logger menu.

Alarm	Alarm Description
Exhaust Fan Alarm	Fault detected on exhaust starter or VFD
Supply Fan Alarm	Fault detected on exhaust starter or VFD
Temp Sensor Input Failure	Failure of a hood temperature sensor
High Temperature Alarm	Indicates a high hood temperature
Pressure Sensor Input Failure	Failure of supply pressure sensor; pressure out of range
Supply Airflow Alarm	Indicates a loss of airflow in the supply fan
Kitchen Fire Detected/Alarm	Indicates a kitchen fire
YASKAWA V1000 ALM	Indicates a specific fault of factory provided VFD
Exhaust/Supply Fan Offline Alarm	Indicates a loss of communication to the VFD(s)
Grease Trapper PCU Filter Status Alarm	Indicates filter change required on Grease Trapper PCU
Low Detergent Alarm	Indicates low detergent level has been detected





## Menus

The controller is equipped with several menus to help guide users with altering program parameters. The following menu can be accessed by pressing the  button. To enter the desired menu, press the  button.

### A. Fan Status

The **Fan Status** menu allows the user to view real-time fan statuses on the system.

TIME	DATE	UNIT##
Exh Fan 1: OFF		Speed
XXX°F		XXX%
*No Supply Airflow		
VFD Off-Line		
Fan in Balancing Mode		



#### ***THIS SCREEN IS AN EXAMPLE OF THE STATUS OF EXHAUST FAN #1***

The temperature on this screen displays real-time temperatures from the sensors linked to the exhaust fan. The speed on this screen displays the real-time speed of the exhaust fan.

If equipped with the airflow proving option, the fan has been turned on and supply airflow has not been detected, “No Supply Airflow” will be displayed.

If the exhaust fan is being controlled from a factory-provided VFD, but the VFD is not communicating back to the controller, “VFD: Off-Line” will be displayed.

If the exhaust fan has been turned on in the balancing menu, “Fan in Balancing Mode” will be displayed.

*Depending on the number of exhaust fans, navigate to other exhaust fan status pages by using the   buttons.*

TIME	DATE	UNIT##
Sup Fan 1: OFF		Speed
		XXX%
VFD Off-Line		
Fan in Balancing Mode		
Sup Fan is Tempering		



#### ***THIS SCREEN IS AN EXAMPLE OF THE STATUS OF SUPPLY FAN #1 - IF EQUIPPED***

The speed on this screen displays the real-time speed of the supply fan.

If the supply fan is being controlled from a factory provided VFD, but the VFD is not communicating back to the controller, “VFD: Off-Line” will be displayed.

If the supply fan has been turned on in the balancing menu, “Fan in Balancing Mode” will be displayed.

If the make-up air unit is currently heating/cooling the air, “Sup Fan is Tempering” will be displayed.

*Depending on the number of supply fans, navigate to other supply fan status pages by using the   buttons.*



## B. Clock

The **Clock** menu allows the user to view and alter the time and date. The user can also adjust the daylight savings time setting.

Clock	
Date:	MM/DD/YY
Hour:	15.30
Day:	Monday

### ***THE CLOCK SCREEN ALLOWS THE USER TO ADJUST THE TIME AND DATE.***

The time/date will not be adjustable on the controller if the user interface is the touch screen.

Clock	
DST:	Enable
Transition time:	60min
Start:	LAST SUNDAY
in MARCH	at 2.00
End:	LAST SUNDAY
in OCTOBER	at 3.00

### ***THIS SCREEN ALLOWS THE USER TO ADJUST DAYLIGHT SAVINGS TIME SETTING.***

The Daylight Savings time feature can be adjusted to meet the current daylight savings time requirements.

## C. Input/Output

The **Input/Output** menu allows the user to quickly view the status of the controller inputs and outputs.

Analog Input	
Temperature Sensor 1	
Input Ch: U1	
Value:	95.0°F

To manually control I/O values, go to the **Service menu > Service settings > I/O Manual Control**.

Similar screens appear for all controller inputs and outputs.

*Your controller may not utilize the input shown. See unit wiring diagram for your specific configuration.*

Digital Input	
Remote On/Off	
Input Ch: ID1	
Status:	Open

Similar screens appear for all controller inputs and outputs.

*Your controller may not utilize the input shown. See unit wiring diagram for your specific configuration.*

Relay Output	
Lights 1	
Output Ch: NO1	
Status:	OFF

Similar screens appear for all controller inputs and outputs.

*Your controller may not utilize the output shown. See unit wiring diagram for your specific configuration.*

Analog Output	
Exhaust Fan 1	
Output Ch: Y1	
Value:	5.00vdc

Similar screens appear for all controller inputs and outputs.

*Your controller may not utilize the output shown. See unit wiring diagram for your specific configuration.*



## D. Service

The **Service** menu allows the user to access several sub-menus regarding controller information, controller overrides, operating hours, BMS configuration, I/O manual management and Probe Adjustment. By accessing the **BMS Config** sub-menu, the user can adjust BMS protocol settings. (BACnet®, LonWorks®, Modbus)

### D. Service

#### a. System Information

The **System Information** sub-menu displays information about the controller and the program loaded on the controller.

#### Information

Accurex	
Code:	
Ver: 2.00	04/12/16
Manual/IOM PN	XXXXXX
Bios: 6.40	11/17/15
Boot: 5.02	09/30/13

**THIS SCREEN SHOWS VERSION, BIOS, AND BOOT INFORMATION. BIOS AND BOOT PERTAIN TO THE CONTROLLER'S FIRMWARE AND OPERATING SYSTEM.**

### D. Service

#### b. VFD Status

The **VFD Status** sub-menu is for commissioning and troubleshooting. This sub-menu allows the user to view the Yaskawa VFD current status.

#### YASKAWA VFD STATUS

Exhaust VFD1	
Speed:	0.0Hz
Ref Frequency:	0.0Hz
Volts out:	0.0V
Rated Current:	0.0A
Amps out:	0.0A
Power out:	0.0kW

**THIS SCREEN ALLOWS THE USER TO VIEW THE CURRENT STATUS OF THE YASKAWA VFD. THERE WILL BE ADDITIONAL VFD SCREENS BASED ON THE NUMBER OF EXHAUST AND SUPPLY VFDs PROVIDED WITH THE SYSTEM.**

**Speed:** This is the actual speed of the Yaskawa VFD in Hertz.

**Ref Frequency:** This is the reference speed signal sent to it from the ASCP controls.

**Volts out:** The voltage on the output side of the Yaskawa VFD.

**Rated Current:** This is the maximum rated current of the Yaskawa VFD.

**Amps out:** This is the current amperage that the Yaskawa VFD is providing to the motor.

**Power out:** This is the current power (kW) that the Yaskawa VFD is providing to the motor.

### D. Service

#### c. Setpoints

The **Setpoints** sub-menu allows the user to view and adjust temperature related parameters.

#### Temperature Interlock

Enable:	ON
Temp On:	115.0°F
Temp Off:	90.0°F
Delay Off:	600s

**THIS SCREEN DISPLAYS THE CURRENT SET POINTS FOR THE TEMPERATURE INTERLOCK FEATURE.**



The user can use the default exhaust fan temperature set points or configure them using the system optimization process. This option satisfies IMC. Fan(s) must automatically activate when cooking operations occur.

- **Temp On Set Point:** The temperature at which the fan(s) automatically turn on based on the temperature of the associated hood. The default is 115°F and is adjustable.
- **Temp Off Set Point:** The temperature at which the fan(s) automatically turn off based on the temperature of the associated hood. It must also satisfy the requirement of the Minimum Off Delay set point. The default is 90°F and is adjustable.
- **Off Delay Set Point:** The amount of time the temperature must remain below the Minimum Off set point before the fan(s) will turn off. The default is 10 minutes and is adjustable.





Exhaust 1 Setpoints		
	Temp	Speed
Low:	90.0°F	50.0%
High:	115.0°F	100.0%
Current Temp:	70.0°F	

High Temperature Alarm	
Enable:	Off
Temp On:	210.0°F
Temp Off:	205.0°F
Highest Temp:	70.0°F

**D. Service**    
d. Fan Balancing

Fan Balancing	
Exhaust Fan 1 Balance:	OFF
Minimum:	50.0
Maximum:	100.0

**D. Service**    
e. Wash Settings

Wash Enable Options	
Wash by Button:	ON
Wash by DI:	OFF
Wash by BMS:	OFF
Wash by Scheduler:	OFF
Wash by AutoStart:	ON
NOTE: Sumps can't be washed by AutoStart	

---

**THIS SCREEN DISPLAYS EXHAUST FAN SETUP.**

**Low Temp:** Temperature that the fan will start to increase in speed from the low speed set point.

**High Temp:** Temperature that the fan will be at the high speed set point.

**Low Speed:** Minimum speed of the fan. (Not adjustable via this menu, see Fan Balancing).

**High Speed:** Maximum speed of the fan. (Not adjustable via this menu, see Fan Balancing).

*Depending on the number of exhaust fans, other exhaust fan setup pages will appear.*

---

**THIS SCREEN DISPLAYS THE HIGH TEMPERATURE ALARM SETTINGS.**

When enabled and the temperature reaches the Temp On set point, the shunt trip output will become active, forcing the electric equipment off. If there is an electric gas valve and it is wired into the VAV system, it will also turn that off. Once the temperature is below the Temp Off set point, the shunt trip output and gas valve will return to normal state.

Remember that the shunt trip breaker will have to be manually reset as well as the electric gas valve.

The **Fan Balancing** sub-menu allows the user to balance exhaust and supply fans easily.

---

**THIS SCREEN ALLOWS THE USER TO BALANCE THE EXHAUST AND SUPPLY FANS.**

*There will be additional fans listed based on the number of exhaust and supply fans on this system.*

**Balance:** When it is in the OFF position, fans will work in normal operation. When set to *MAX* the fan will be forced to full speed. When set to *MIN* the fan will be forced to minimum speed.

**Minimum:** Based on the setting of *Balance*, the user can adjust the minimum speed to meet the requirements for the design of the system.

**Maximum:** Based on the setting of *Balance*, the user can adjust the maximum speed to meet the requirements for the design of the system.

**Make sure to return the mode of operation to OFF when balancing is complete. If the mode of operation is left in either MIN or MAX, the fan will not turn off.**

The **Wash Settings** sub-menu allows the user to adjust all wash settings for the hoods and/or sumps.

---

**THIS SCREEN DISPLAYS THE USER TO ADJUST HOW THE WASH CYCLE BEGINS.**

**Wash by Button:** If ON, this option allows the user to begin a wash cycle by a button on the user interface.

**Wash by DI:** If ON, this option allows a wash cycle to begin through a digital input on the controller.

**Wash by BMS:** If ON, this option allows a wash cycle to begin through the BMS interface.

**Wash by Scheduler:** If ON, this option allows a wash cycle to begin at a specific time during the day.

**Wash by AutoStart:** If ON, this option allows a wash cycle to begin automatically after a fan exhausting the hood has been running for a pre-determined time. AutoStart will only enable Auto Scrubber hoods and cannot be used to engage duct sump washes.



Hood Wash Setup	
Pre-Wash Delay:	10s
Pre-Soak Spray:	60s
Pre-Soak Det:	10s
Soak Time:	60s
Between Seq:	-5s
Fan Dry Enable	YES

Hood Wash Setup	
Disable wash during temp interlock?	YES
Cold water mist during kitchen fire?	OFF

Sump Wash Setup	
Pre-Wash Delay:	10s
Between Seq:	60s

Hood Wash History	
H1 Wash Count:	0
H2 Wash Count:	0
H3 Wash Count:	0
H4 Wash Count:	0
Last Complete Wash Hood:	0
0/00/00	12:00:00am

Hood Wash History	
Hood washes during low detergent alarm	
H1 Wash Count:	0
H2 Wash Count:	0
H3 Wash Count:	0
H4 Wash Count:	0

Sump Wash History	
S1 Wash Count:	0
S2 Wash Count:	0
S3 Wash Count:	0
S4 Wash Count:	0
Last Complete Wash Sump:	0
0/00/00	12:00:00am

---

**THIS SCREEN ALLOWS THE USER TO SELECT OPTIONS FOR THE HOOD WASH CYCLE.**

---

**Pre-Wash Delay:** Count down time until wash begins after initiated.

**Pre-Soak Spray:** Time allotted to soaking the filters.

**Pre-Soak Det:** Time allotted to injecting detergent into the line while soaking the filters. This detergent injection begins 30 seconds after the pre-soak spray has begun.

**Soak Time:** Time allotted to allowing the detergent and water to set on/in filters and soak.

**Between Seq:** Time between the first and second sequence (top and bottom manifold).

**Fan Dry Enable:** If enabled, this will turn fans on after wash cycle is completed to draw out leftover moisture and dry plenum in hood.

---

**THIS SCREEN ALLOWS THE USER TO SELECT ADDITIONAL OPTIONS FOR THE HOOD WASH CYCLE.**

---

**Disable wash during temp interlock?:** By selecting YES, a hood that is currently washing will abort the wash cycle of that hood and the hood will be prevented from being washed until temp interlock is no longer present for that hood section.

**Cold water mist during kitchen fire?:** By selecting ON, a hood will enable the cold water mist during a kitchen fire. This option will only be visible if cold water mist is provided with the hood.

---

**THIS SCREEN ALLOWS THE USER TO SELECT OPTIONS FOR THE SUMP WASH CYCLE.**

---

**Pre-Wash Delay:** Count down time until sump wash begins after initiated.

**Between Seq:** Time between the sumps (if multiple sumps are present). This allows the site's water heater to regenerate hot water for the next sump in the wash sequence.

---

**THIS SCREEN PROVIDES THE NUMBER OF WASHES PER HOOD AND A DATE/TIME STAMP OF THE LAST COMPLETED HOOD WASH.**

---



---

**THIS SCREEN PROVIDES THE NUMBER OF WASHES PER HOOD DURING A LOW DETERGENT ALARM.**

---



---

**THIS SCREEN PROVIDES THE NUMBER OF WASHES PER SUMP AND A DATE/TIME STAMP OF THE LAST COMPLETED SUMP WASH.**

---



Sump Wash History	
Sump washes during low detergent alarm	
S1 Wash Count:	0
S2 Wash Count:	0
S3 Wash Count:	0
S4 Wash Count:	0

---

**THIS SCREEN PROVIDES THE NUMBER OF WASHES PER SUMP DURING A LOW DETERGENT ALARM.**

---

Reset Wash History	
Reset all of the wash history? NO	

---

**THIS SCREEN ALLOWS THE USER TO RESET ALL OF THE WASH HISTORY (FOR BOTH HOODS AND SUMPS). CHANGE THE NO ON THE SCREEN TO A YES TO RESET.**

---

Wash Schedule Settings	
Current Date/Time: 12:00:00am 4/12/2016	
Daily Wash Start Time: 10:00pm	

---

**THIS SCREEN ALLOWS THE USER TO ADJUST THE DAILY WASH SCHEDULE TIME. THIS SCREEN WILL ONLY APPEAR IF THE WASH BY SCHEDULER IS ENABLED.**

---

AutoStart Wash Setup	
Min fan run:	480min
Max daily washes:	2

---

**THIS SCREEN ALLOWS THE USER TO ADJUST AUTOSTART SETTINGS. THIS SCREEN WILL NOT BE VISIBLE UNLESS WASH BY AUTOSTART IS ENABLED.**

---

**Min fan run:** Cumulative time a hood fan has to be on before allowing hood to be washed. (Once time exceeds the minimum fan run time and the fans shut off, the hood will start to wash).

**Max daily washes:** Maximum number of hood washes initiated through an AutoStart allowed per day for each hood section.

Prime Detergent Pump	
Prime the detergent pump? NO	
Change OFF to ON to start detergent pump.	

---

**THIS SCREEN ALLOWS THE USER TO PRIME THE DETERGENT PUMP. CHANGING NO TO YES WILL ENABLE THE DETERGENT PUMP. WHILE PRIMING, PRESS THE ↺ BUTTON TO STOP THE DETERGENT PUMP FROM PRIMING.**

---

Hood Test Wash Setup	
Seq Time	30s
Seq Det Tim	10s
Drip Dry Time	10s
Fan Dry Time	15s
Start Test Wash?	NO

---

**THIS SCREEN ALLOWS THE USER TO ADJUST SETTINGS FOR A HOOD TEST WASH AND ALSO START A TEST WASH. TEST WASHES ALLOW FOR EXPEDITED SEQUENCE TIMES TO QUICKLY MONITOR A FULL WASH SEQUENCE. CHANGING THE NO TO A YES WILL START A TEST WASH. DURING A TEST WASH, PRESS THE ↺ BUTTON TO ABORT THE TEST WASH SEQUENCE.**

---

**Seq Time:** Time for each manifold (top and bottom) to spray.

**Seq Det Time:** Time for the detergent to inject into the line for each manifold (top and bottom). Detergent injection starts 5 seconds after the sequence time begins.

**Drip Dry Time:** Time after both manifolds are done spraying (time before fan dry, if enabled).

**Fan Dry Time:** Time allotted to running the fan after a hood wash is done drip drying.



Sump Test Wash Setup	
Wash Time:	30s
Det Time:	10s
Start Test Wash?	NO

Hood # Wash Setup	
Seq 1 Time:	0
Seq 1 Det Time:	150s
Seq 2 Time:	140s
Seq 2 Det Time:	0s
Drip Dry Time:	60s
Fan Dry Time:	120s

Sump # Wash Setup	
Sump Wash Time:	60s
Sump Det Time:	15s

**D. Service**  
f. BMS Config

BMS Configuration	
Protocol:	BACnet MSTP
BACnet Plugin?	YES

MODBUS SETUP	
Address:	1
Baudrate	9600

**THIS SCREEN ALLOWS THE USER TO ADJUST SETTINGS FOR A SUMP TEST WASH AND ALSO START A TEST WASH. TEST WASHES ALLOW FOR EXPEDITED SEQUENCE TIMES TO QUICKLY MONITOR A FULL WASH SEQUENCE. CHANGING THE NO TO A YES WILL START A TEST WASH. DURING A TEST WASH, PRESS THE ↶ BUTTON TO ABORT THE TEST WASH SEQUENCE.**

**Wash Time:** Time for spraying each duct sump during test wash.

**Det Time:** Time for the detergent to inject into the line for each sump during test wash. Detergent injection starts 5 seconds after the sequence time begins.

**THIS SCREEN ALLOWS THE USER TO ADJUST SETTINGS FOR A HOOD WASH. MULTIPLE HOOD WASH SCREENS MAY BE VISIBLE, DEPENDING ON HOW MANY HOODS ARE BEING CONTROLLED BY THE ASCP**

**Seq 1 Time:** Time for top manifold to spray the filters.

**Det Time:** Time for the detergent to inject into the line during the top manifold spray. Detergent injection starts 5 seconds after the sequence time begins.

**Seq 2 Time:** Time for bottom manifold to spray the filters.

**Det Time:** Time for the detergent to inject into the line during the bottom manifold spray. Detergent injection starts 5 seconds after the sequence time begins.

**THIS SCREEN ALLOWS THE USER TO ADJUST SETTINGS FOR A HOOD WASH. MULTIPLE HOOD WASH SCREENS MAY BE VISIBLE, DEPENDING ON HOW MANY HOODS ARE BEING CONTROLLED BY THE ASCP.**

**Sump Wash Time:** Time for sump to wash.

**Det Time:** Time for the detergent to inject into the line during the sump wash. Detergent injection starts 5 seconds after the sump wash time begins.

The **BMS Config** sub-menu allows the user to view and alter BMS protocol settings. If the BMS protocol is BACnet or Modbus, additional screens allow further configuration. See below for details. To access the **BMS Config** sub-menu, enter the service password (Default=1000).

**THIS SCREEN ALLOWS THE USER TO SELECT THE BMS PROTOCOL. ALL BMS PROTOCOLS REQUIRE A COMMUNICATIONS CARD INSTALLED IN THE SERIAL CARD PORT, LOCATED ON THE FACE OF THE CONTROLLER.**

If the protocol is BACnet MSTP or BACnet IP/Eth, the user can change common BACnet parameters via the controller. The BACnet Plugin must be set to YES.

**THIS SCREEN ALLOWS THE USER TO ADJUST MODBUS PARAMETERS.**

*This screen only appears if the selected BMS protocol is set to Modbus.*

The address is the Modbus address of the card installed in the SERIAL CARD port located on the face of the controller. (Factory Default = 1).

The Baud Rate should be set to the BMS baud rate. (Factory Default = 9600).



### MSTP SETUP

Instance:	77000
Baudrate	38400
MAC Addr:	0
MaxMasters:	127
MaxInfoFrames:	20

### BACnet Read/Write

Function:	Read
Update?	Yes

\*Cycle unit power to confirm write command.

### **THIS SCREEN ALLOWS THE USER TO ADJUST BACNET MSTP PARAMETERS.**

*This screen only appears if the selected BMS protocol is set to BACnet MSTP and BACnet Plugin = YES.*

If a BACnet MSTP card has been installed, the default parameters can be changed via the controller display. Factory settings are shown in the screen to the left.

#### To view current parameters:

1. Power on controller and allow several minutes to initialize.
2. Go to **BMS Config** menu and view BACnet Read/Write screen.
3. Change *Function* to *Read* and *Update?* to *YES*.

Current BACnet MSTP parameters should now be displayed in the BACnet MSTP SETUP screen. If all values appear to be zeros, consult the factory. (Make sure you have allowed several minutes for the controller to initialize).

*Values may appear to be zero prior to setting the Function to READ.*

#### To change BACnet MSTP parameters:

1. Power on controller and allow several minutes to initialize.
2. Go to BMS Config menu and view MSTP SETUP screen.
3. Move cursor to desired parameter by pressing the  $\uparrow$ / $\downarrow$  buttons. Press  $\leftarrow$  to select the parameter to change. Press the  $\uparrow$ / $\downarrow$  buttons to adjust the parameter. Press  $\leftarrow$  to save adjusted value.
4. Once desired parameters have been entered, go to BACnet Read/Write screen. Change *Function* to *Write* and *Update?* to *YES*.
5. Reboot the controller by cycling power to the unit. Allow several minutes for the controller to initialize.
6. View MSTP parameters. If changed values did not save, contact the factory.

### TCP/IP SETUP

Instance:	77000
IP set by:	DHCP
IP:	128.2.104.134
Subnet:	255.255.000.000
Gateway:	128.2.0.12

### TCP/IP SETUP

DNS 1:	192.168.001.001
DNS 2:	192.168.001.001
Type:	IP

### BACnet Read/Write

Function:	Read
Update?	Yes

\*Cycle unit power to confirm write command.

### **THIS SCREEN ALLOWS THE USER TO ADJUST BACNET IP PARAMETERS.**

*This screen only appears if the selected BMS protocol is set to BACnet IP/Eth and BACnet Plugin = YES.*

If a BACnet IP card has been installed, the default parameters can be changed via the controller display. **The card is in DHCP mode from the factory.** Once communication is established, the user can enter static IP parameters.

#### To view current parameters:

1. Power on controller and allow several minutes to initialize.
2. Go to **BMS Config** menu and view BACnet Read/Write screen.
3. Change *Function* to *Read* and *Update?* to *YES*.

Current BACnet IP parameters should now be displayed in the BACnet TCP/IP SETUP screen. If all values appear to be zeros, consult the factory. (Make sure you have allowed several minutes for the controller to initialize).

*\*Values may appear to be zero prior to setting the Function to READ.*

#### To change BACnet TCP/IP parameters:

1. Power on the controller and allow several minutes to initialize.
2. Go to **BMS Config** menu and view TCP/IP SETUP screen.
3. Move cursor to desired parameter by pressing the  $\uparrow$ / $\downarrow$  buttons. Press  $\leftarrow$  to select the parameter to change. Press the  $\uparrow$ / $\downarrow$  buttons to adjust the parameter. Press  $\leftarrow$  to save adjusted value.
4. Once desired parameters have been entered, go to BACnet Read/Write screen. Change *Function* to *Write* and *Update?* to *YES*.
5. Reboot the controller by cycling power to the unit. Allow several minutes for the controller to initialize.
6. View TCP/IP parameters. If changed values did not save, contact the factory.





## D. Service

- g. Service Settings
  - a. Fan Operation
  - b. I/O Manual Control
  - c. Hood Manual Control
  - d. Light Manual Control
  - e. Wash Manual Control
  - f. Sensor Calibration
  - g. User Save/Restore
  - h. Alarm History Reset

## D. Service

- g. Service Settings
  - a. Fan Operation

### Full Speed Settings

Full Speed Override  
Duration: 10min  
Full Speed Status: OFF

### Kitchen Fire Settings

Exhaust fan operation during fire:  
Fans On - Full Speed  
Supply fan operation during fire:  
Fans Off

### Exhaust Fan Operation

Minimum On 1s  
Minimum Off 1s

### Supply Fan Operation

Supply Fan Airflow  
Proving Delay: 15s

### Supply Fan Operation

Minimum Tempering Setpoints  
Supply Fan 1: 66.0%  
Supply Fan 2: 66.0%  
Supply Fan 3: 66.0%  
Supply Fan 4: 66.0%

The **Service Settings** sub-menu allows the user to adjust fan operation, manually enable/disable inputs and outputs, hoods, and lights, calibrate sensors, create or restore user settings, and reset the alarm history log.

In **Fan Operation**, the user will be able to adjust full speed override settings, kitchen fire settings and exhaust/supply fan operation settings.

---

#### ***THIS SCREEN ALLOWS THE USER TO ADJUST THE FAN OVERRIDE/FAN 100% SETTINGS.***

**Full Speed Override Duration:** When the fans are running and the full speed override button is pressed, the fans will ramp up to full speed for this time limit. Once this time limit is reached, the fans will return to a speed based on hood temperature.

**Full Speed Status:** This will display whether the fans are in full speed mode. (ON = full speed button has been pressed, OFF = normal fan operation).

---

#### ***THIS SCREEN ALLOWS THE USER TO ADJUST THE KITCHEN FIRE SETTINGS.***

**Exhaust fan operation during fire:** During a kitchen fire, this will determine exhaust fan operation. (Default will be Fans On - Full Speed)

**Supply fan operation during fire:** During a kitchen fire, this will determine supply fan operation. (Default will be Fans Off). This will only be visible/adjustable **IF** there is at least one supply fan controlled by the ASCP system.

**NOTE: Do not adjust these settings after a fire test has been completed.**

---

#### ***THIS SCREEN ALLOWS THE USER TO ADJUST MINIMUM ON/MINIMUM OFF TIME FOR EXHAUST FANS.***

**Minimum On:** This prevents all exhaust fans from shutting off for the maximum time selected. (Factory Default = 1 second)

**Minimum Off:** This prevents all exhaust fans from turning on for the minimum time selected. (Factory Default = 1 second)

---

#### ***THIS SCREEN ALLOWS THE USER TO ADJUST THE SUPPLY FAN AIRFLOW PROVING DELAY***

This screen will only be visible if the ASCP is controlling at least one supply fan and is configured for Airflow Proving.

**Supply Fan Airflow Proving Delay:** This will delay the time for the ASCP to allow for the supply fan to prove before logging a supply fan proving alarm. (Factory Default = 15 seconds)

---

#### ***WHEN A SUPPLY FAN IS ON AND TEMPERING, SETTINGS ON THIS SCREEN WILL PREVENT THE FANS FROM FALLING BELOW A SPECIFIC SPEED***

This screen will only be visible if the ASCP is controlling at least one supply fan. Factory default minimum tempering speeds are 66.0%.



### Supply Fan Operation

Pressure Setpoints  
Setpoint: 0.000iwc  
Pressure: 0.000iwc

### Supply Fan Operation

Modulating Setup  
Band: 50.0  
Integration Time: 180s  
Derivative Time: 12s  
Dead Band OFF  
Above Set Point 1.0  
Below Set Point 1.0

## D. Service

g. Service Settings

b. I/O Manual Control

### Analog Input

Temperature Sensor 1  
Input Ch: U1  
Manual Control: OFF  
Manual Value: 0  
Value: 70.0°F

### Digital Input

Remote On/Off  
Input Ch: ID1  
Manual Control: OFF  
Manual Position: CLOSED  
Status: Open

### Relay Output

Lights 1  
Output Ch: NO1  
Manual Control: OFF  
Manual Position: OFF  
Status: ON

### Analog Output

Exhaust Fan 1  
Output Ch: Y1  
Manual Control: OFF  
Manual Value: 0.00vdc  
Value: 5.00vdc

**WHEN ONE SUPPLY FAN SPEED IS CONTROLLED VIA STATIC PRESSURE, THESE SETTINGS WILL BE VISIBLE AND ADJUSTABLE.**

Supply fan speed can be controlled via a pressure differential between two spaces. Pressure setpoints and different PID loop settings can be adjusted with this option. It is recommended to contact the factory for assistance before adjusting these settings.

In **I/O Manual Control**, the user will be able to manually adjust inputs/outputs.

**NOTE:** The manual adjustment of these input and/or outputs should only be adjusted in the event of troubleshooting. We suggest these parameters only be changed with the advice of factory personnel.

**Manual Control:** Allows the user to override the analog input for troubleshooting.

**Manual Value:** The value to force the input to when in an override state.

**Value:** The current value of the analog input.

*Similar screens appear for all additional controller analog inputs.*

**Manual Control:** Allows the user to override the digital input for troubleshooting.

**Manual Position:** The value to force the input to when in an override state.

**Status:** The current state of the digital input.

*Similar screens appear for all additional controller digital inputs.*

**Manual Control:** Allows the user to override the digital input for troubleshooting.

**Manual Position:** The value to force the output to when in an override state.

**Status:** The current state of the relay output.

*Similar screens appear for all additional controller relay outputs.*

**Manual Control:** Allows the user to override the analog output for troubleshooting.

**Manual Value:** The value to force the input to when in an override state.

**Value:** The current value of the analog output.

*Similar screens appear for all additional controller analog outputs.*



**D.  Service**

- g. Service Settings
- c. Hood Manual Control

In **Hood Manual Control**, the user will be able to manually turn on/off individual hood systems (turn on/off individual fans).

**Hood Sys Manual On/Off**

1. ON
2. OFF
3. ON

*Depending on how many hood systems there are, the user may see less/more hoods that can be controlled.*

**D.  Service**

- g. Service Settings
- d. Light Manual Control

In **Light Manual Control**, the user will be able to manually turn on/off individual light circuits.

**Light Manual On/Off**

1. ON
2. OFF

*Depending on how many light circuits were configured on the system, the user may see less/more lights that can be controlled.*

**D.  Service**

- g. Service Settings
- e. Wash Manual Control

The **Wash Manual Control** sub-menu allows the user to initiate individual hood and sump washes.

**Wash Manual On/Off**

Hoods

- 1: OFF
- 2: OFF
- 3: OFF
- 4: OFF

---

***THIS SCREEN ALLOWS THE USER TO INITIATE INDIVIDUAL HOOD WASHES BY CHANGING THE NO TO A YES NEXT TO EACH AUTO SCRUBBER HOOD NUMBER. DEPENDING ON THE NUMBER OF LINKED AUTO SCRUBBER HOODS, THIS SCREEN MAY SHOW FEWER HOODS.***

---

**Sump Manual On/Off**

Sumps

- 1: OFF
- 2: OFF
- 3: OFF
- 4: OFF

---

***THIS SCREEN ALLOWS THE USER TO INITIATE INDIVIDUAL SUMP WASHES BY CHANGING THE NO TO A YES NEXT TO EACH DUCT SUMP. DEPENDING ON THE NUMBER OF LINKED DUCT SUMPS, THIS SCREEN MAY SHOW FEWER SUMPS.***

---

**D.  Service**

- g. Service Settings
- f. Sensor Calibration

In **Sensor Calibration**, the user will be able to create temperature offsets for hood sensors and/or static pressure supply sensors, *if equipped*.

**Sensor Calibration**

Temperature Sensor 1

Input Ch: U1

Offset: 0.0°F

Value: 70.0°F

**Offset:** This adjustable value can be used to calibrate the sensor with an offset value. (Factory Default = 0.0°F)

**Value:** This is the current value of the probe. (offset adjustment is added).

*Similar screens are available for the remaining probes and static pressure sensor, if equipped.*



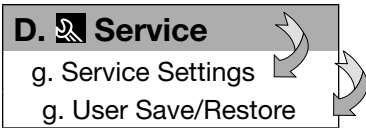

In **User Save/Restore**, the user will be able to save and restore the default parameters stored in memory.



If the user would like to save their settings, move the cursor to the SAVE position and change to ON. This will save all of the current parameters into memory as Service Settings. If the user would like to restore to these values at some point in the future, moving the cursor to the RESTORE position and selecting ON, will restore the controller to the user saved defaults.

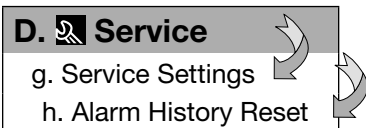

In **Alarm History Reset**, the user will be able reset the alarm history log.

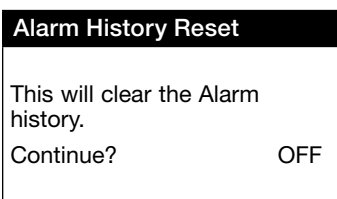

**THIS SCREEN ALLOWS THE USER TO CLEAR THE ALARM FROM MEMORY.**

If the user would like to clear the alarm log, move the cursor to the OFF position and change to ON.

## E. Manufacturer

The **Manufacturer** menu allows the user to access several sub-menus regarding controller configuration, I/O configuration, factory settings, controller initialization pages, and factory save/restore pages. These changes are to be completed under factory advisement only!

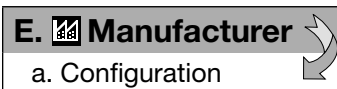

The **Configuration** sub-menu allows the user to adjust an assortment of items including units (temperature), clock mode (12hr or 24hr), buzzer enable/disable, and allows for modifying passwords. However, these changes are to be completed under factory advisement only!

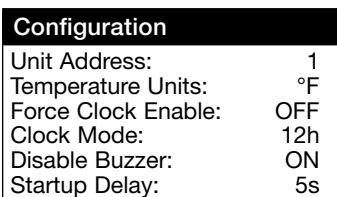

**THIS SCREEN DISPLAYS AND ALLOWS ADJUSTMENT OF THE UNIT SETTINGS.**

**Unit Address:** This is a reference to the unit address of the controller. It cannot be adjusted here.

**Temperature Units:** The temperature units can be adjusted between Celsius and Fahrenheit.

**Force Clock Enable:** This provides the ability to enable a clock for the controller without clock device on board. This should remain set at OFF.

**Clock Mode:** 12 hour or 24 hour.

**Disable Buzzer:** When turned to ON, the on-board buzzer is disabled. (Buzzer will still sound when gas is reset if the system was configured with the gas reset option).

**Startup Delay:** This is the time delay added at start-up. This should remain set at 5 seconds.

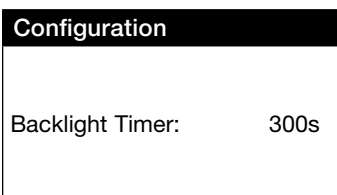

**THIS SCREEN DISPLAYS AND ALLOWS ADJUSTMENT OF THE BACKLIGHT TIMER (FACTORY DEFAULT = 300 SECONDS)**



Configuration	
Analog Input Filtering	
Enable:	OFF
Input 1:	19s
Input 2:	19s
Input 3:	19s
Input 4:	19s
Input 5:	19s

Configuration	
Manual Control Reset	
Enable:	OFF
Time:	0min

Configuration	
Modbus Settings (VFDs)	
Port:	FieldBus 2
BaudRate:	19200
Data:	8, None, 2

Modulating Setup	
Supply Fan	
Cntrl:	REV PID
Band:	50
Integration Time:	180s
Derivative Time:	12s
Min:	-1000
Max:	0
Output Period:	500ms

Passwords	
	
Insert new passwords	
Service (PW1):	0000
Manufacturer (PW2):	0000

---

**THIS SCREEN DISPLAYS AND ALLOWS ADJUSTMENT OF ANALOG INPUT FILTERING**

---

Similar screens appear for all additional controller analog inputs.

---

**THIS SCREEN PROVIDES A MEANS TO RESET MANUAL I/O.**

---

Changing the Enable parameter to ON will reset all of the manual I/O settings after the time (Factory Default = 0 minutes expires).

---

**THIS SCREEN DISPLAYS THE VFD MODBUS SETTINGS**

---

This screen will only be visible if at least one Modbus VFD is controlled by the controller.

---

**THIS SCREEN DISPLAYS THE STATIC PRESSURE CONTROL SETTINGS.**

---

This screen will only be visible if one supply fan is configured on the system and the supply fan speed is controlled via static pressure.

---

**THIS SCREEN ALLOWS THE USER TO CHANGE THE SERVICE (PW1) AND MANUFACTURER PASSWORD (PW2).**

---

This default service (PW1) password is 1000.

## E. Manufacturer

### b. I/O Configuration

The **I/O Configuration** sub-menu allows adjustment of all controller inputs and outputs. These screens are available to provide further information and allow for more adjustments on all inputs and outputs on the controller. However, these changes are to be done under factory advisement only!

#### Analog Input

Temp Sensor 1  
En: ON Ch: U1  
Normal PT1000  
Offset: 0.0°F  
Value: 70.0°F

*These are examples of analog input screens. Similar screens appear for all additional controller analog inputs used.*

#### Analog Input

Temp Sensor 2  
Out of Range Alarm  
Power Delay: 15s  
Run Delay: 15s

#### Digital Input

Remote On/Off  
Enable: ON  
Channel: ID1  
Action: OPEN  
Delay: 0s  
Status: Open

*This is an example of a digital output screen. Similar screens appear for all additional controller digital inputs used.*

#### Relay Output

Lights 1  
Enable: ON  
Channel: NO1  
Status: OFF

*This is an example of a relay output screen. Similar screens appear for all additional controller relay outputs used.*

#### Analog Output

Exhaust Fan 1  
Enable: ON  
Channel: Y1  
Action: DIRECT  
Minimum: 0.00vdc  
Maximum: 10.00vdc  
Value: 0.00vdc

*This is an example of an analog output screen. Similar screens appear for all additional controller analog outputs used.*



**E.  Manufacturer**

**c. Factory Settings**

The **Factory Settings** sub-menu allows adjustments to the overall system setup. Adjusting any of these settings will affect basic functions of the controller. Upon adjusting any of these settings, the controller power should be cycled. Changes are to be done under factory advisement only!

**Factory Settings 1**

Brand:	ACCUREX
System Selection:	S
Interface:	KEYPAD
Hoods:	1
Sumps:	0
Exhaust Fans:	1

*This is an example of the first factory settings screen. Additional screens will be accessible.*

**E.  Manufacturer**

**d. Initialization**

The **Initialization** sub-menu allows the user to reinitialize the controller. Reinitializing the controller will result in a non-customized controller and is to be done under factory advisement only!

**Initialization**

DEFAULT INSTALLATION	
Erase user settings and install global default values:	NO

*Shown here is the default installation screen. To initialize, move the cursor to NO using the enter button, press the up bottom to change to YES, and press the enter button.*

**E.  Manufacturer**

**e. Factory Save/Restore**

The **Factory Save/Restore** sub-menu allows the user to save or restore the factory parameters. This is to be done under factory advisement only!

**Factory Save/Restore**

	
Save?	OFF
Restore?	OFF
Auto Restore?	No

---

***THIS SCREEN ALLOWS THE USER TO SAVE AND RESTORE THE FACTORY DEFAULT PARAMETERS STORED IN MEMORY.***

---

The Factory Settings include the Factory default parameters and the unit setup code. If the user would like to restore to these parameters, move the cursor to the Restore position and change to ON.

**Factory Delete**

	
CLEAR ALL SAVED DATA	
FACTORY+USER:	OFF

---

***THIS SCREEN ALLOWS THE USER TO CLEAR ALL SAVED DATA.***

---

## Initial System Start-Up

1. Clean the control cabinet of any debris that may have entered the cabinet during installation.
2. Add detergent to the detergent tank in the cabinet.
3. Turn power on to the control cabinet and fans (if applicable).
4. Check electrical power is correct for hood controls, lights (if applicable), and fans (if applicable).
5. Confirm the CAREL controller is operational; display should be illuminated.
6. Check for any current system alarms, and correct if present.
7. If system is controlling fans, turn the fans on via the user interface. Check fan rotation and confirm exhaust and supply air volumes are correct (per design). After this has been completed, turn the fans off.
8. Turn on water supply, checking for any leaks before going further.
9. **Prime the detergent pump.** On the CAREL controller, navigate to the Service > Wash Settings > “Prime Detergent Pump” menu screen. Changing “OFF” to “ON” will start the detergent pump. This can also be done from the touchscreen (if provided).

### Prime Detergent Pump

Prime the detergent pump? OFF

Change NO to YES to start detergent pump.

Monitor the detergent line and press the ESC key once the detergent reaches the hot water line. Pressing ESC will stop the detergent pump.

10. If washing Auto Scrubber hoods, and the filter doors are not installed, install them now.
11. **Run a test wash.** On the CAREL controller, navigate to Service > Wash Settings > Hood Test Wash Setup menu screen. Adjust the times as necessary on the screen; change NO to YES. A test wash will start.

### Hood Test Wash Setup

Seq Time:	30s
Seq Det Time:	10s
Drip Dry Time:	10s
Fan Dry Time:	15s
Start Test Wash?	NO

Ensure no leaks are present and water pressure is between 40 to 70 PSI while washing. At any time, the test wash can be aborted by pressing the ESC key.





## Wash Operation *(if equipped)*

A wash cycle can be initiated through a number of different options.

**Wash by Button** (Factory default = **ON**): A wash can be initiated through pressing either the “WASH” button (if equipped with a keypad) or by pressing “WASH ON/OFF” icon (if equipped with a touch screen).

**Wash by Digital Input** (Factory default = **OFF**): A wash can be initiated through engaging a configured digital input on controller. For the correct terminals to wire this digital input, please reference the Auto Scrubber Control Panel wiring diagram.

**Wash by BMS Interface** (Factory default = **OFF**): A wash can be initiated through engaging a BMS read/write point. Point lists can be found in the Auto Scrubber Control Panel IOM.

**Wash by Scheduler** (Factory default = **OFF**): A wash can be initiated daily at a specific time. If this option is enabled, this time can be field adjusted within the controller and touch screen, if equipped.

**Wash by Auto Start** (Factory default = **ON**): Each individual hood can be washed after that hood’s fan(s) has been running for a pre-determined time (factory default is 8 hours). This time setting and the maximum allowable auto start washes can be field adjusted within the controller and touch screen, if equipped.

### NOTE

Auto Start will only enable to Auto Scrubber hoods. It cannot be used to engage duct sump washes.

With exception to the Auto Start option, when a wash cycle has been initialized the Auto Scrubber hoods will be washed in order starting with Auto Scrubber hood 1. If duct sumps are also connected to this system, they will be washed in order after the Auto Scrubber hoods have been washed.

A wash cycle can be stopped at any time by pressing the “WASH” button (if equipped with a keypad) or by the “WASH ON/OFF” icon (if equipped with a touch screen).

An Auto Scrubber hood will be prevented, or abort operating in the wash cycle, should one of the following events occur:

- A kitchen fire alarm is detected.
- A sensor linked to the Auto Scrubber hood fails.
- The option to disable a wash during temperature interlock is on (factory defaulted on) and a sensor linked to the Auto Scrubber hood exceeds the temperature interlock on setpoint.
- If the Auto Scrubber control panel is equipped with no fan controls (ASCP-W) and the fan input is triggered.

A fan exhausting an Auto Scrubber hood cannot be controlled by the user (turned on and off) while that Auto Scrubber hood is washing. If multiple Auto Scrubber hoods are employed, a fan linked to an Auto Scrubber hood which is not currently washing can be controlled by the user (turned on and off) as normal.

### NOTE

Duct sumps may be controlled by this Auto Scrubber system. A duct sump is a grease reservoir installed in low points of grease duct which also requires routine wash downs.

When duct sumps are washing, fans cannot run, unless:

- A kitchen fire is detected
- A sensor linked to any Auto Scrubber hood fails, or any temperature sensor exceeds the temperature interlock on setpoint
- If the Auto Scrubber control panel is equipped with no fan controls (ASCP-W) and the fan input is triggered



# Wash Sequence of Operation

## NOTE

The previously stated items regarding ending a wash cycle/skipping a hood wash still apply. Please use this in conjunction with the information found in Sequence of Operation section found on pages 19 and 20.

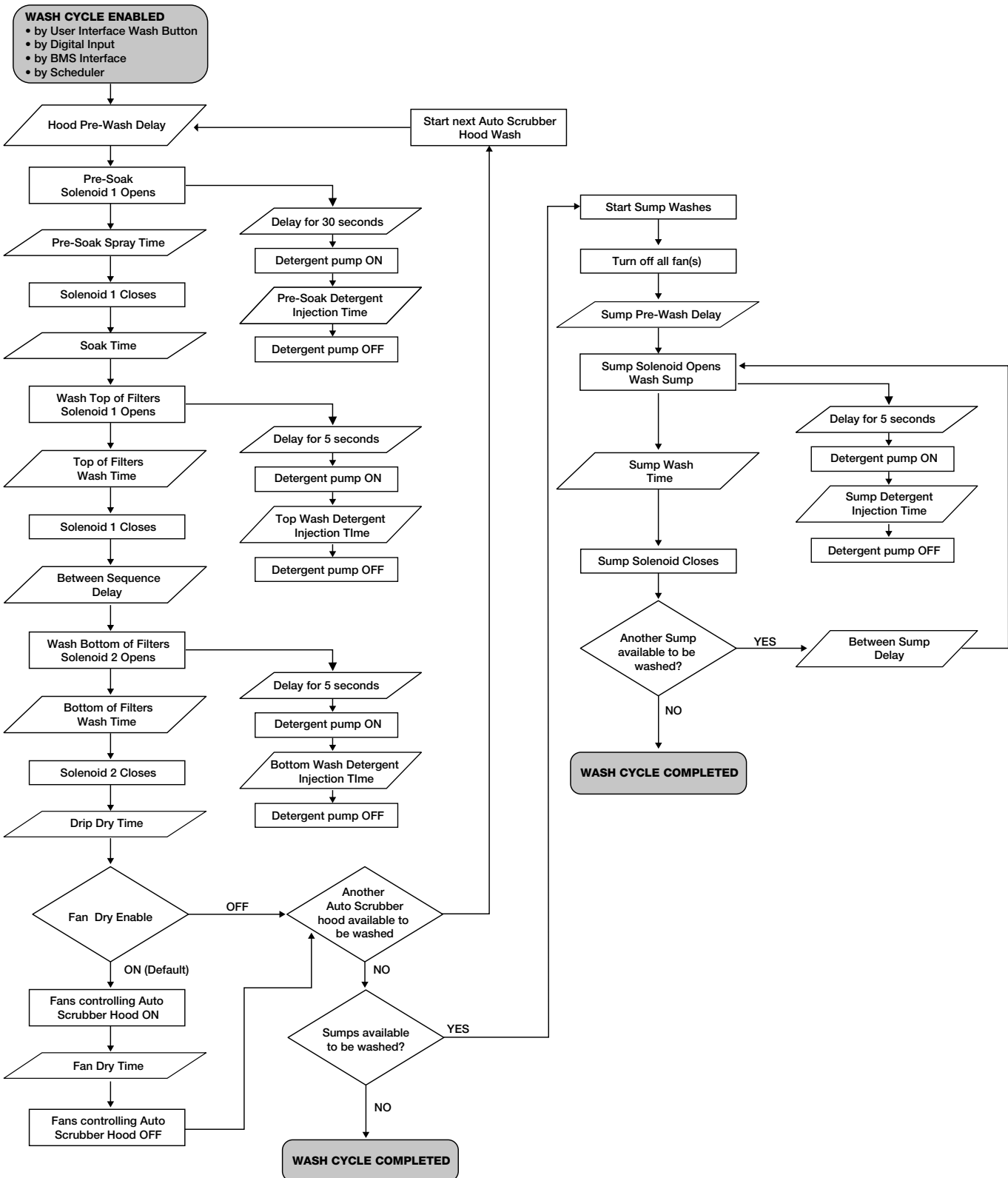

# Wash Sequence of Operation, *continued*

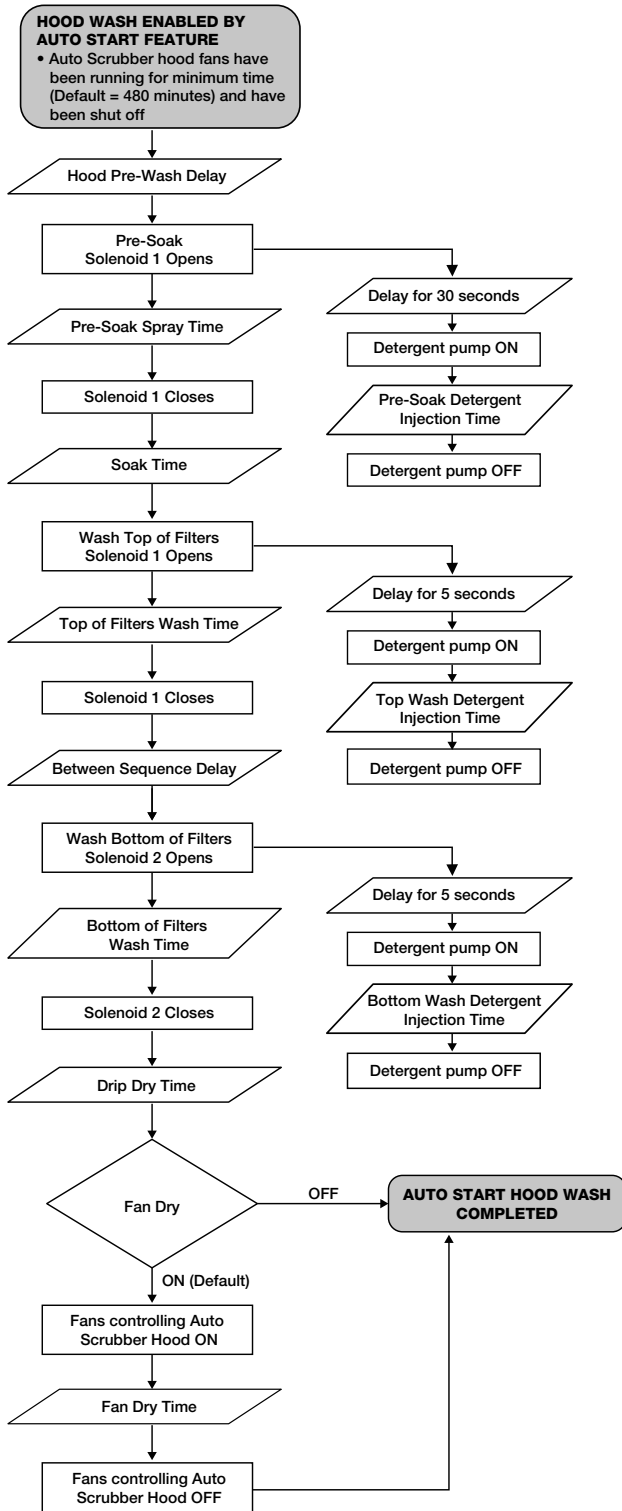

Wash Cycle Factory Default Times		
Wash Cycle Stage	Time (seconds) Based on Filter Type	
	Baffle Grease-X-Tractor™ Energy Recovery	Grease Grabber™
Pre-Wash Delay	10	10
Pre-Soak Spray	60	60
Pre-Soak Detergent	30	30
Soak	60	60
Top Wash	120	350
Top Wash Detergent	60	150
Between Sequence Delay	-5	-5
Bottom Wash	120	240
Bottom Wash Detergent	60	60
Drip Dry	60	60
Fan Dry	120	120

**NOTE**

The wash times are based on filter cleaning tests using filters coated heavily with oil and then baked-on using high temperatures. Actual required cleaning times will vary based on cooking equipment, fuel type, cooking frequency, and the food prepared. The table shown above should be used as a starting point. After a few weeks, the field can make adjustments as necessary based on the cleanliness of the filters upon removal/inspection.



## Keypad Navigation

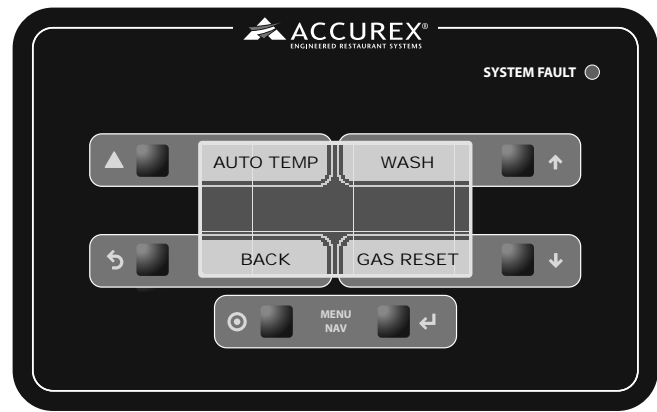
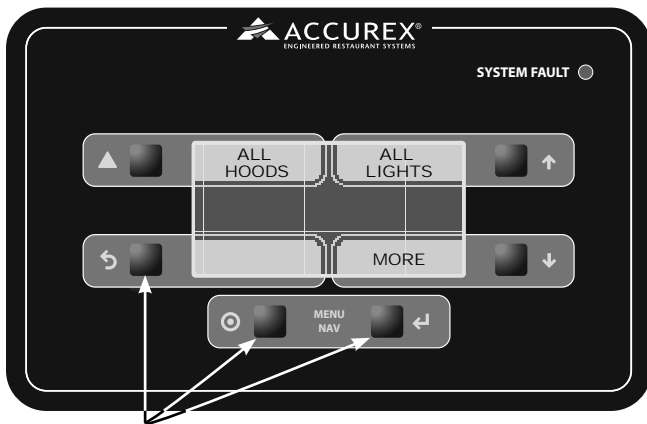

When **'BUTTON(S)'** are mentioned in the description below, we are referring to the 'squares' on the keypad. The following information details the Daily Operations of the ASCP keypad buttons and their functions.

**HOODS/ALL HOODS** - Momentarily pressing the 'ALL HOODS' button will turn on all hoods (fans) associated with the system. If all of the hoods (fans) are on, the background behind 'ALL HOODS' text will be dark. Pressing the same button again will turn off all hoods. If 'HOODS' is displayed instead of 'ALL HOODS', individual hood system control is available. Pressing the 'HOODS' button accesses another screen where individual hoods (fans) can be turned on and off. Press the button next to each hood system identified to enable/disable that hood/fan. Press the 'MORE' button (if applicable) to access additional hood systems. Press the 'BACK' button to return to the previous screen.

**ALL LIGHTS/LIGHTS, if equipped** - Momentarily pressing the 'ALL LIGHTS' button will activate all the lights for hoods associated with the system. If all hood lights are on, the background behind the 'ALL LIGHTS' text will be dark. Pressing the button again turns off the lights for all hoods. If 'LIGHTS' is displayed instead of 'ALL LIGHTS', individual light control is available. Pressing 'LIGHTS' button will access another screen where individual light circuits can be turned on and off. Press the light button next to each light circuit identified to enable/disable the lights for the hood(s). Press the 'MORE' button (if applicable) to access additional hood light circuits. Press the 'BACK' button to return to the previous screen.

**MORE, if equipped** - Momentarily pressing the 'MORE' button will navigate to an additional screen where the user will be able to enable/disable heating or cooling on the make-up air unit (if equipped with the auto tempering option) and/or reset the gas valve (if equipped with gas reset option).

**BACK, if equipped** - Momentarily pressing 'BACK' button will navigate to the previous screen.

**AUTO TEMP, if equipped** - Momentarily pressing the 'AUTO TEMP' button will enable the make-up air unit to heat and cool the air based on heating/cooling inlet air sensors. If auto tempering is on, the background behind 'AUTO TEMP' will be dark. Pressing the same button again will turn off auto tempering and therefore prevent your make-up air unit from heating/cooling the air.

**GAS RESET, if equipped** - Momentarily pressing the 'GAS RESET' button will open the electric gas valve and allow gas to flow to the appliance(s). If the gas valve is on, the background behind the 'GAS RESET' text will be dark. Once this is turned on, the gas reset will be permanently enabled. The gas valve will close only when a high temperature alarm (if equipped) or kitchen fire is detected.

### NOTE

Immediately after resetting gas valve, make sure to relight all standing pilot lights to prevent gas from flowing into the kitchen. As a reminder, the controller will beep three times upon resetting the value.

**WASH, if equipped** - Momentarily pressing the 'WASH' button will engage a wash cycle. If a wash cycle is currently occurring, pressing this button momentarily will stop the wash cycle.

### Display functionality and control:

To change the display contrast, hold the buttons next to the Alarm ⚠ and Program Ⓢ icons simultaneously while pressing the buttons next to the ↓ and ↑ arrows. The down arrow will make the screen lighter and the up arrow will make the screen darker.

Upon any alarm, the 'SYSTEM FAULT' red LED light on the face of the keypad starts flashing. Once all alarms are corrected, this LED will stop flashing and no longer be illuminated.

Through the middle of the screen, system status messages will be displayed as a reference. These system statuses will include:

- Current alarms
- Time remaining on fan 100% override timer (if on)
- Hoods that are on by temperature interlock
- Hoods that are on by the user interface
- Lights that are on by the user interface
- Fans that are in balancing mode

The keypad also includes indicators next to buttons that correspond to help the buttons on the controller. These can be used to navigate through the controller using the keypad. To access the main menu, simply press and hold the button next to the Program Ⓢ icon for **five seconds** or until the screen changes to the main menu.



# Touch Screen Navigation



**Momentarily press or tap to access the menu or enable or disable the action of the associated icon. All icons surrounded by blue are momentarily push buttons.**



**ALL LIGHTS ON/OFF** (if equipped) - turns on all hood lights associated with the system. When all hood lights are activated, the light bulbs within the icon illuminate.

Tapping the icon again will turn off the lights.



**INDIVIDUAL LIGHT ON/OFF** (if equipped) - access a secondary screen menu whereby control over individual light circuits is available. Tap the icon next to each light



circuit identified to enable/disable. Press the back arrow to return to the home screen.



**ALL HOODS ON/OFF** (if equipped) - turns on all hoods (fans) associated with the system. If all hoods are operating, the fan propellers in the icon starts spinning. Press again to turn off all hoods.



**INDIVIDUAL HOOD SYSTEMS ON/OFF** (if equipped) - allows control over multiple fans that are not tied to the same hood. Access to a secondary menu screen allowing the



ability to enable/disable individual hood systems. Press the back arrow to return to the home screen.



**100% OVERRIDE ON/OFF** (if equipped) - forces the fans that are currently operating to full speed. (This icon will only be visible if at least one exhaust fan is running).

When turned on, the third bar on the icon blinks green. Fans will return to the speed determined by the hood temperature after the timer has expired (default time is 10 minutes). Pressing this icon when 100% OVERRIDE is on, will also return the fans to the speed determined by the hood temperature.



**AUTO TEMPERING ON/OFF** (if equipped) - enables the make-up air unit to automatically heat and/or cool the air based on the inlet air temperature. When auto tempering is enabled, the thermometer illuminates. Pressing the icon again disables auto tempering, the make-up air unit's heat and/or cooling capabilities.



**GAS RESET ON/OFF** (if equipped) - turns on the gas to the appliance(s); opens the electric gas valve. The gas valve will close (gas will be shut off) if a fire occurs or high temperature is detected in any hood. When the gas is on, the icon will show 'ON'.



**WASH ON/OFF** - used to start and stop a wash cycle for all Auto Scrubber hoods and duct sumps.



**PCU FILTER STATUS** (if equipped) - indicates loaded/clogged filter(s) in the Pollution Control Unit (PCU). If filters are satisfactory, filter image will remain gray.

The image of the affected filter(s) will flash red. Once clogged, the filter(s) must be replaced.



**TEMP INTERLOCK INDICATOR** (if equipped) - indicates if at least one hood is operating in temperature mode. If the

fan(s) were not turned on via the ALL HOODS ON/OFF or INDIVIDUAL HOOD SYSTEMS ON/OFF and the temperature in the hood is above the temperature interlock set point, this icon will animate. The fan(s) will continue to operate until the temperature is below the set point for the amount of time in the temperature interlock settings.



**ENERGY SAVINGS INDICATOR** (if equipped) - this appears if at least one fan is operating. Displays real-time electrical energy savings due to reducing fan speeds.

## NOTE

This percentage does not take into consideration additional savings from lowering the airflow requirements for heated and/or cooled make-up air and building HVAC air.



**HELP** - this will display a help menu and navigation tips.



**NAVIGATION BAR** (arrow at bottom of the screen) - pulls up the hidden NAVIGATION menu allowing access to alarms, home, and settings/configuration/information screens. This is available on every screen.





The alarm icon directs you to the alarms screen. **This icon will illuminate red and blink when an alarm has been triggered.**

The middle icon directs you to the home screen.

The icon on the far right allows navigation to the settings/configuration/information menu screen.

Pressing either of the black arrows to the right and left of these three buttons will hide the navigation menu bar.

### Service Password Screen

#### NOTE

The Service Password must be entered to access the SETTINGS, CONFIGURATION and INFORMATION screen. The default service password is 1000.



### Active Alarms Example



## General Information

Any field surrounded by a box with a white fill indicates that it is editable.

If an editable field displays a numerical value and the user taps the field, a number keypad will display. After entering the desired value, press the Enter button.

If the editable field is an alphanumeric value, a standard keyboard will display. After entering the desired value, press the Enter button.

The field may also display a multiple choice ON/OFF, or a checkmark box. For the ON/OFF fields, press the box opposite of the checked box to change the option from either OFF to ON or visa versa. For checkmark boxes, to unlink an item momentarily press on the box to remove the checkmark or conversely, to link an item, press the box to add a checkmark.



## Settings

### • Fire



**Lights Out in Fire:** Changing this setting to ON will turn all hood lights off during a fire.

**Exhaust On in Fire:** Changing this setting to ON will turn all exhaust fans controlled by the system to full speed during a fire.

**Supply On in Fire:** Changing this setting to ON will turn all supply fans controlled by the system to full speed during a fire.

**Electric Gas Valve Present:** Changing this setting to ON will enable the gas reset option; provides a means of manually resetting an electric gas valve.



## Settings - continued

### • Exhaust Fans

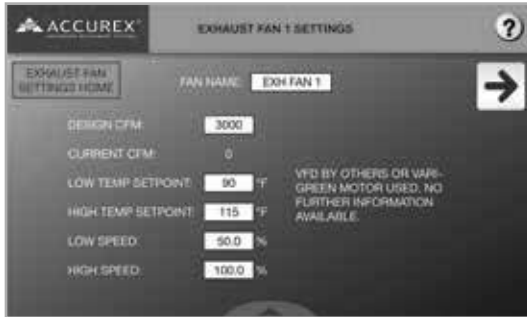

**Fan Name:** User can adjust the “nickname” of the fan to something such as “FRYER FAN”.

**Design CFM:** Set from factory (full speed, exhaust airflow rate).

**Current CFM:** Current CFM exhausted from the fan.

**Low Temp Setpoint:** Temperature at or below this setpoint will cause the fan to run at the low speed.

**High Temp Setpoint:** Temperature at or above this setpoint will cause the fan to run at the high speed.

**Low Speed:** Lowest fan operational speed.

**Highest Speed:** Highest fan operational speed.

### NOTE

The fans will modulate speed when the temperature is between the low and high temp setpoints.

### • Supply Fans



**Fan Name:** User can adjust the “nickname” of the fan to something such as “HOOD1 SUPPLY”.

**Design CFM:** Set from factory (full speed, supply airflow rate).

**Current CFM:** Current CFM supplied from the fan.

**Low Speed:** Lowest fan operational speed.

**Highest Speed:** Highest fan operational speed.

### • Lights



**Light Circuit Name:** User can adjust the nickname of each light circuit.

### • Temperature Interlock & Override



**Temperature Interlock Enabled:** User can enable or disable temperature interlock.

### WARNING

Temperature interlock is a code requirement in most jurisdictions. DO NOT DISABLE THIS OPTION UNLESS INSTRUCTED BY THE FACTORY OR AUTHORITY HAVING JURISDICTION. DO NOT CHANGE THIS SETTING ONCE THE SYSTEM HAS PASSED INSPECTION.

**Temperature On Setpoint:** The temperature at which the fan(s), if off, will automatically turn on.

**Temperature Off Setpoint:** Temperature at which the fan(s) will turn off once the time delay setpoint is reached - assuming the fan(s) have not been turned on manually by the touch screen.

**Time Delay Off Setpoint:** Amount of time the fan(s) need to be below the temperature off setpoint before the fan(s) will shut off.

**100% Override Button Timer:** Amount of time the fans are at full speed when the 100% override button is pressed.



## Settings - continued

### • General Wash Settings

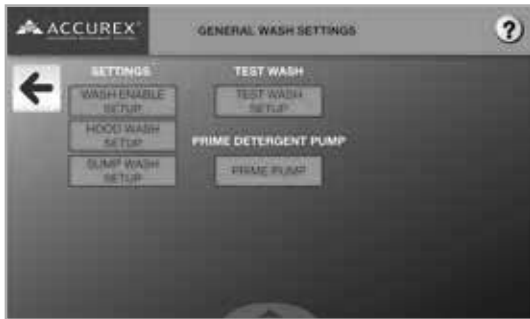

To update wash settings, press on the corresponding buttons under “SETTINGS”. To start or alter test wash settings, press on the corresponding button under “TEST WASH”. To prime the detergent pump, press the corresponding button under “PRIME DETERGENT PUMP”.

### • Wash Enable Setup



**Wash by Button:** Enable or disable wash by button option.

**Wash by Digital Input:** Enable or disable wash by digital input option.

**Wash by BMS:** Enable or disable wash through BMS option.

**Wash by Scheduler:** Enable or disable wash through daily scheduled time option.

**Wash by Auto Start:** Allow wash to automatically start after fan serving hood shuts off.

### • Wash Scheduler Settings



**Current Date/Time:** Current date and time.

**Daily Wash Start Time:** Enable wash to start at specific time every day.

### • Auto Start Wash Settings



**Minimum Fan Run Time:** Minimum amount of time fan exhausting Auto Scrubber hood has to be running before hood will be set up to automatically wash after fan shuts off.

**Maximum Number of Daily Washes:** Maximum number of wash cycles that can be initiated through the Auto Start feature.





## Settings - continued

### • Hood Wash Setup



**Pre Wash Delay:** Count down time until wash begins after initiated.

**Pre Soak Spray:** Time allotted to soaking the filters.

**Pre Soak Detergent Time:** Time allotted to injecting detergent into the line while soaking the filters. This detergent injection begins 30 seconds after the pre-soak spray has begun.

**Soak Time:** Time allotted to allowing the detergent and water to set on/in filters and soak.

**Between Sequence Delay:** Time between the first and second sequence (top and bottom manifold).

**Disable Wash during Temperature Interlock:** By selecting ON, a hood that is currently washing will abort the wash cycle of that hood and the hood will be prevented from being washed until temp interlock is no longer present for that hood section.

**Fan Dry Enable:** If enabled, this will turn fans on after wash cycle is completed to draw out leftover moisture and dry plenum of hood.

**Enable Cold Water Mist During Fire:** By selecting ON, a hood will enable the cold water mist during a kitchen fire.

**Last Completed Hood Wash:** A date and time stamp of the last completed Auto Scrubber hood washed.

### • Sump Wash Setup



**Pre Wash Delay:** Count down time until sump wash begins after initiated.

**Between Sequence Delay Time:** Time between the sumps (if multiple sumps are present).

### • Sump # Settings



**Sump Wash Time:** Time for sump to wash.

**Detergent Injection Time:** Time for detergent to inject into line during the sump wash. Detergent injection starts 5 seconds after the sump wash time begins.

### • Test Wash Setup



Enter into Hood Test Wash setup screens by pressing “HOOD TEST WASH SETUP” button. Enter into Sump Test Wash setup screens by pressing “SUMP TEST WASH SETUP” button. Start a test wash by pressing the “START TEST WASH” button. Once a test wash is started, press the “STOP WASH” button to stop a test wash prematurely.

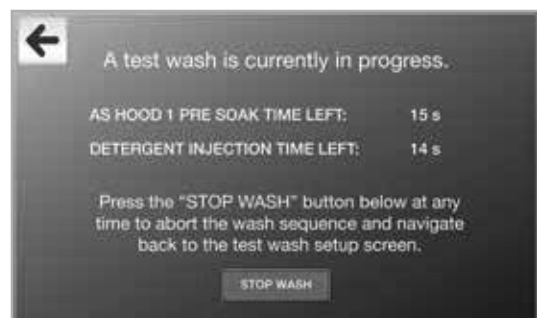

## Settings - continued

### • Hood Test Wash Setup



**Sequence Time:** Time for each manifold (top and bottom) to spray.

**Detergent Injection Time:** Time for the detergent to inject into the line for each manifold (top and bottom). Detergent injection starts 5 seconds after the sequence time begins.

**Drip Dry Time:** Time after both manifolds are done spraying (time before fan dry, if enabled).

**Fan Dry Time:** Time allotted to running the fan after a hood wash is done drip drying.

### • Sump Test Wash Setup



**Sump Wash Time:** Time for spraying each duct sump during test wash

**Detergent Injection Time:** Time for the detergent to inject into the line for each sump during test wash. Detergent injection starts 5 seconds after the sequence time begins.

### • Prime Detergent Pump



Press the “STOP PUMP” button to stop the detergent pump from priming.

## Configuration

### • Date / Time



**Adjust Date:** Adjust the date. DD/MM/YY format.

**Adjust Time:** Adjust the time.

To store the adjusted date and time in both the touch screen and the main controller, press ‘UPDATE DATE/TIME’.

### • Hoods



**Associated Temperature Sensors:** Link sensors to the hood by checking or unchecking the boxes.

**Associated Exhaust Fans:** Link exhaust fans to the hood by checking or unchecking boxes.

**Associated Supply Fans:** Link supply fans to the hood by checking or unchecking the boxes.

**Hood System:** Based on the selections on the screen, this provides the hood system number that the hood currently is linked to.

**Auto Scrubber Hood #:** Based on the factory settings, this number is provided if the current hood is an Auto Scrubber hood, and if it is, what number Auto Scrubber hood.

Press the “AUTO SCRUBBER HOOD # WASH SETTINGS” button to navigate to a screen where the individual hood wash settings can be adjusted.



## Configuration - continued

### • Auto Scrubber Hood # Wash Settings



**Sequence 1 Time:** Time for top manifold to spray the filters.

**Sequence 1 Detergent Time:** Time for the detergent to inject into the line during the top manifold spray. Detergent injection starts 5 seconds after the sequence time begins.

**Sequence 2 Time:** Time for bottom manifold to spray the filters.

**Sequence 2 Detergent Time:** Time for the detergent to inject into the line during the bottom manifold spray. Detergent injection starts 5 seconds after the sequence time begins.

**Drip Dry Time:** Time after both manifolds are done spraying (time before fan dry, if enabled).

**Fan Dry Time:** Time allotted to running the fan after a hood wash is done drip drying.

**Wash Count:** Number of completed washes for hood.

**Wash Count During Low Detergent Alarm:** Number of washes per hood during a low detergent alarm.

### • Hood System Scheduling



Allows the user to set up a scheduled time each hood system should turn on/off during the day. Can adjust the occurrence, time on and time off. In order for the scheduling to be used, the Enable check box must be selected.

### • Fan Balancing



Balancing allows the user to easily balance the exhaust and supply fans.

#### **Mode of Operation: Normal Operation**

Fans operate based off the fans on/off buttons and temperatures.

#### **Mode of Operation: Balance Minimum**

Forces the fans on and at the speed shown in the minimum speed box.

#### **Mode of Operation: Balance Maximum**

Forces the fans on and at the speed shown in the maximum speed box.

**Minimum Speed:** Adjust the minimum speed as necessary for the design of the system.

**Maximum Speed:** Adjust the maximum fan speed as necessary for the design of the system.

### NOTE

Make sure to return the mode of operation to 'NORMAL OPERATION' when balancing is complete. If the mode of operation is left in Balance Minimum or Balancing Maximum, the fan(s) will not turn off.



## Information

### • System Information



Displays important system information including firmware and software versions.

### • Temperature Sensors



All current sensor temperatures are shown on this information screen.

### • Alarms



Alarms will show all current alarms. In the event of an alarm, the alarm page will automatically be displayed. The alarm description, date and time will be displayed for each current fault. If no faults exist, 'No Active Alarms' will be displayed. Once a fault is corrected, it will automatically be cleared.

### • Trending



Trending provides additional information that shows history trending for exhaust fans, supply fans and temperature sensors. Scrolling forward or backward in time can be done using the orange colored arrow buttons.



# Troubleshooting

<b>Problem: Smoke spilling out of hoods at 100% operation (ASCP-V only)</b>	
Maximum fan speed has been scaled down from 100%	Increase exhaust fan maximum speed to 100%. Refer to information provided on page 28 to adjust setpoints.
Improper hood design	Check hood overhang, cross drafts or proper make-up air
<b>Problem: Smoke spilling out of hood(s)</b>	
Fan minimum speed is set too low	Increase exhaust fan minimum speeds (ASCP-V only). Refer to information provided on page 28 to adjust setpoints.
Improper hood design	Check hood overhang, cross drafts or proper make-up air
<b>Problem: Fans do not turn up to maximum speed (ASCP-V only)</b>	
Dirty temperature sensor	Clean grease from temperature sensor
High temperature set point is set too high	Decrease the high temperature set point (115°F default). Refer to information provided on page 28 to adjust set points.
Fans are in balancing mode	Check balancing menus to determine if fans are in balancing mode. Refer to information provided on page 28 to adjust set points.
Fan 100% button is activated	Check 100% timer setting
<b>Problem: Fans do not turn down to minimum speed (ASCP-V only)</b>	
Dirty temperature sensor	Clean grease from temperature sensor
Low temperature set point is set too low	Increase the low temperature set point (90°F). Refer to information provided on page 28 to adjust set points.
Fans are in balancing mode	Check balancing menus to determine if fans are in balancing mode
<b>Problem: Exhaust fan on and supply fan off</b>	
Broken supply fan belt	Replace fan belt
Fire fault	Check fire suppression microswitch connection
Exhaust fan VFD in local control	Put exhaust fan VFD back into remote control
Supply fan breaker tripped	Reset breaker
<b>Problem: Supply fan on and exhaust fan off</b>	
Broken exhaust fan belt	Replace fan belt
Supply fan VFD in local control	Put supply fan VFD back into remote control
Exhaust fan breaker tripped	Reset breaker
<b>Problem: Fan wheel rotates in wrong direction</b>	
Fan wiring incorrect	Switch any two power wires on the fan motor <b>OR</b> change PAR b1-14 from 00 to 01 on the VFD (if ASCP-V with factory provided VFDs)
<b>Problem: 100% override does not increase exhaust speed (ASCP-V only)</b>	
Exhaust already at 100% due to hood temperature	Proper operation
<b>Problem: Fan button is on, but fans do not turn on</b>	
Broken fan belt	Replace fan belt
VFD fault	Check VFD for faults
<b>Problem: Fan button is off, but the fans will not turn off</b>	
ASCP is operating in temperature interlock mode. Temperature interlock indicator on keypad or touch screen will be on.	The temperature in the hood is still above the temperature interlock off set point. It will automatically turn off once below the setpoint and off delay time has expired.
<b>Problem: Hood light(s) button on, but actual lights are not on</b>	
Light bulbs are burned out	Replace hood light bulbs
Bad wiring connection	Verify lights are wired to the correct terminals. Refer to the lights wiring instructions on page 8
<b>Problem: Fans do not turn on automatically</b>	
Temperature interlock is disabled	Enable the temperature interlock option (default is enabled) in the set point menu
Interlock set point set too high	Decrease the temperature interlock on set point (refer to page 28)



# Troubleshooting

<b>Problem:</b> Pressure sensor alarm	
Kinked hose	Remove kink or replace hose
Controlled space not holding pressure	Adjust the static pressure set point or change supply mode
<b>Problem:</b> Kitchen fire alarm	
Kitchen fire is in progress; fire suppression has dumped	Evacuate the facility immediately and contact your local fire department.
Fire system microswitch is in the fire position	Check the fire suppression microswitch connections
<b>Problem:</b> Temperature sensor input failure	
Faulty wiring to temperature sensor	Check wiring at ASCP control panel (refer to page 10) and at hood connection
Incorrect programming	Check the temperature sensor settings (consult factory).
Dirty/Faulty sensor	Clean or replace sensor
<b>Problem:</b> Exhaust / supply fan alarm - general	
Look at VFD display for fault identification, or attempt reset overload on fan motor starter	With ASCP-V panels with factory provided VFDs, refer to the Yaskawa Quick Start Guide for fault and tips to correct. Once corrected, recycle power to the VFD via the breaker. Wait until all power is drained from the VFD before turning power back on.
<b>Problem:</b> Exhaust / supply VFD fault. Fault code “CE” or “CALL” (ASCP-V only)	
Faulty communication wiring between VFD and controller	Check all communication wiring between VFD and the ASCP controller. Confirm all wiring corresponds with factory wiring diagram.
Incorrect programming in VFD	Check VFD communication parameters
Incorrect programming in ASCP controller	Check ASCP controller factory settings pages (consult factory)
<b>Problem:</b> Fan is making grinding/winding noise and/or appears to struggle to operate (ASCP-V only)	
Carrier frequency on VFD needs adjustment	Change parameter C6-02 on the VFD anywhere between values 01 and 06, testing the fan at maximum speed with each adjustment. Set this parameter at whichever value corrects this issue.
Issue with fan bearings/drive components	Check fan bearings and fan drive components. Replace if necessary.
<b>Problem:</b> Keypad connected via factory-supplied RJ25 cable to J10 port on main controller, but keypad displays a blank screen	
ASCP controller/panel is off	Turn panel on
Contrast on keypad has been adjusted	Press and hold top left button and top middle hidden button on the keypad overlay. While holding these buttons down, repeatedly press the bottom left button (makes the screen darker) or bottom right button (makes the screen lighter) until suitable to read.
Faulty keypad	Replace keypad
<b>Problem:</b> Touch screen displaying “Communication Error” screen	
Communication to touch screen is faulty	Check communication wiring from bottom of touch screen (-, +, O) and confirm this is connected back to main CAREL® controller on the J25 port (-, +, O)
<b>Problem:</b> Fault light flashing red on the keypad; alarm button red on touch screen	
Fault has been detected in ASCP system	Clear the faults. If the faults will not clear, there is a current fault on system. Correct the fault and then proceed to clear the fault.
<b>Problem:</b> Pollution control unit (PCU) filter status alarm	
PCU filter is clogged/full	Replace filter
<b>Problem:</b> An Auto Scrubber hood is not washing routinely (wash cycle not activating).	
Is the system in fault?	Fire, high temperature and sensor faults will prevent a wash from starting. Correct these faults.
Are you relying on the hood to wash manually?	In the control panel Wash Enable option, verify the setting for “Wash by Button” is set to ON. Ensure (recommended after start up) the kitchen employees are pressing the WASH button daily.



## Variable Frequency Drive (VFD) Information - if equipped

Yaskawa V1000 (200-230 VAC and 460 VAC) or Yaskawa A1000 (575 VAC) variable frequency drives (VFDs) will be provided if the ASCP-V is configured to use VFDs to control the fans. These drives will come programmed from the factory, and little to no adjustment will be necessary in most cases. For more in-depth information on wiring and programming these drives, please utilize the Quick Start Guide provided with the package. This quick start guide and other technical manuals can also be found on the Yaskawa website at [www.yaskawa.com](http://www.yaskawa.com).



Parameter	Description	Default Value	Factory Adjustment
<b>b1-01</b>	Reference Source Speed Control Method	01	02
<b>b1-02</b>	Run Source – Start/Stop Control Method	01	02
<b>b1-07</b>	LOCAL/REMOTE Run Selection	00	01
<b>b1-17</b>	Run Command at Power Up	00	01
<b>C1-01</b>	Acceleration Time 1	10.00 seconds	30.00 seconds
<b>C1-02</b>	Deceleration Time 1	10.00 seconds	30.00 seconds
<b>E1-01</b>	Input Voltage	Dependent on drive type	Dependent on motor voltage*
<b>E2-01</b>	Motor Rated Current	Dependent on drive type	Dependent on motor FLA (full load amperage)*
<b>H5-01</b>	Drive Node Address	1F	Dependent on VFD address*
<b>H5-02</b>	Communication Speed Selection	03	04
<b>H5-09</b>	CE Detection Time	2.0 seconds	10.0 seconds
<b>L2-01</b>	Momentary Power Loss Operation Selection	00	02
<b>L5-01</b>	Number of Auto Restart Attempts	00	10

\*See ASCP wiring diagram for more information.

### Resetting the VFD Faults

Upon a VFD fault, first determine the cause of the fault and correct. Typically, if the drive detects a fault, it will remain inoperable until that fault has been corrected and the drive has been reset.

Once a fault has been corrected, the easiest way to clear the displayed fault on the VFD is to shut off power to the drive from the power source (breaker). Wait for the VFD to fully discharge and then restore the power.

Upon correcting a minor fault, recycling power may not be necessary. Simply press , then press  twice.

Once the fault has been corrected and the drive has been reset, the main controller alarm should automatically be cleared. See page 24 for details.

# Model V1000

## Changing Parameters

**Step 1:** V1000 Digital Operator power-up state.

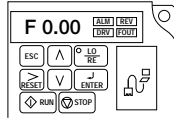

### Step 2: Select Parameter Menu

Press **[V]** two times until the digital operator show the parameter menu (PAr) then press **[ENTER]**.

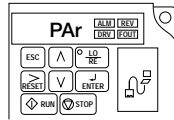

### Step 3: Select Parameter

Press **[RESET]** to select the digit you would like to change. Next use **[^]** and **[V]** to select the parameter group, sub-group or number.

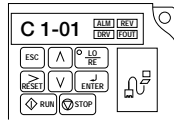

Once the parameter you wish to change is displayed on the screen and the digit furthest to the right is flashing, press **[ENTER]**.

### Step 4: Change Parameter Value

Press **[RESET]** to select the digit of the parameter value you would like to change.

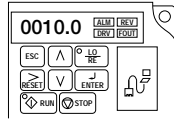

Modify the parameter value using **[^]** and **[V]** and press **[ENTER]** to save the new value.

## Monitor Motor Frequency and Motor Current

**Step 1:** V1000 Digital Operator power-up state:

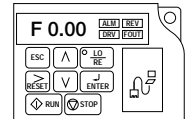

### Step 2: Output Frequency

Press **[^]** until the **FOUT** LED turns on. The display now shows the actual drive output frequency in hertz (Hz).

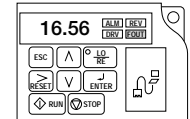

### Step 3: Motor Current

Press **[^]** again will show the motor output current. The 'A' behind the value means 'Amps'.

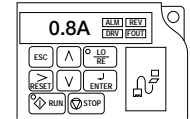

# Model A1000

## Changing Parameters

**Step 1:** A1000 Digital Operator power-up state.

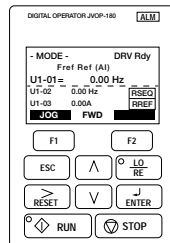

### Step 4: Change Parameter Value

Press **[RESET]** to select the digit of the parameter value you would like to change.

Modify the parameter value using **[^]** and **[V]** and press **[ENTER]** to save the new value.

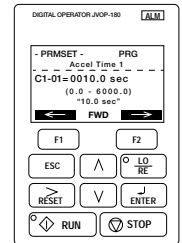

### Step 2: Select Parameter Menu

Press **[V]** two times until the digital operator shows the programming menu, then press **[ENTER]**.

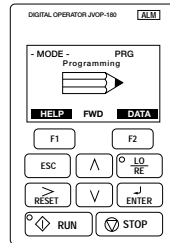

## Monitor Motor Frequency and Motor Current

With the drive running, press **[^]** until reaching the Monitor Menu. This will display output frequency and amperage of the motor.

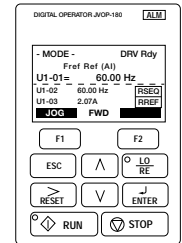

### Step 3: Select Parameter

Press **[RESET]** to select the digit you would like to change. Next use **[^]** and **[V]** to select the parameter group, sub-group or number.

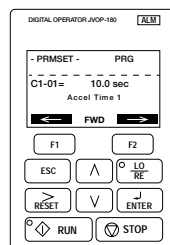

Once the parameter you wish to change is displayed on the screen and the digit furthest to the right is flashing, press **[ENTER]**.





## BMS Points List • ASCP v2.00 Modbus / BACnet®

Type	BACnet Device Instance: 77000 (default) Analog = AV, Integer = AV, Digital = BV			Modbus - RTU/TCP Address: 1 (default)	Read Write	Description
	Instance	Name	Units	Register		
Analog	11	H1_Ctemp	°F	40012	R	Hood 1 Control Temperature
Analog	12	H2_Ctemp	°F	40013	R	Hood 2 Control Temperature
Analog	13	H3_Ctemp	°F	40014	R	Hood 3 Control Temperature
Analog	14	H4_Ctemp	°F	40015	R	Hood 4 Control Temperature
Analog	15	H5_Ctemp	°F	40016	R	Hood 5 Control Temperature
Analog	16	H6_Ctemp	°F	40017	R	Hood 6 Control Temperature
Analog	17	H7_Ctemp	°F	40018	R	Hood 7 Control Temperature
Analog	18	H8_Ctemp	°F	40019	R	Hood 8 Control Temperature
Analog	19	H9_Ctemp	°F	40020	R	Hood 9 Control Temperature
Analog	20	H10_Ctemp	°F	40021	R	Hood 10 Control Temperature
Analog	51	Ef1_Amps	amperes	40052	R	Exhaust Fan 1 Amps from VFD
Analog	52	Ef2_Amps	amperes	40053	R	Exhaust Fan 2 Amps from VFD
Analog	53	Ef3_Amps	amperes	40054	R	Exhaust Fan 3 Amps from VFD
Analog	54	Ef4_Amps	amperes	40055	R	Exhaust Fan 4 Amps from VFD
Analog	55	Ef5_Amps	amperes	40056	R	Exhaust Fan 5 Amps from VFD
Analog	56	Ef6_Amps	amperes	40057	R	Exhaust Fan 6 Amps from VFD
Analog	57	Ef7_Amps	amperes	40058	R	Exhaust Fan 7 Amps from VFD
Analog	58	Ef8_Amps	amperes	40059	R	Exhaust Fan 8 Amps from VFD
Analog	59	Ef9_Amps	amperes	40060	R	Exhaust Fan 9 Amps from VFD
Analog	60	Ef10_Amps	amperes	40061	R	Exhaust Fan 10 Amps from VFD
Analog	71	Sf1_Amps	amperes	40072	R	Supply 1 Amps from VFD
Analog	72	Sf2_Amps	amperes	40073	R	Supply 2 Amps from VFD
Analog	73	Sf3_Amps	amperes	40074	R	Supply 3 Amps from VFD
Analog	74	Sf4_Amps	amperes	40075	R	Supply 4 Amps from VFD
Analog	81	Ef1_kW	kilowatts	40082	R	Exhaust Fan 1 Power Output
Analog	82	Ef2_kW	kilowatts	40083	R	Exhaust Fan 2 Power Output
Analog	83	Ef3_kW	kilowatts	40084	R	Exhaust Fan 3 Power Output
Analog	84	Ef4_kW	kilowatts	40085	R	Exhaust Fan 4 Power Output
Analog	85	Ef5_kW	kilowatts	40086	R	Exhaust Fan 5 Power Output
Analog	86	Ef6_kW	kilowatts	40087	R	Exhaust Fan 6 Power Output
Analog	87	Ef7_kW	kilowatts	40088	R	Exhaust Fan 7 Power Output
Analog	88	Ef8_kW	kilowatts	40089	R	Exhaust Fan 8 Power Output
Analog	89	Ef9_kW	kilowatts	40090	R	Exhaust Fan 9 Power Output
Analog	90	Ef10_kW	kilowatts	40091	R	Exhaust Fan 10 Power Output
Analog	101	Sf1_kW	kilowatts	40102	R	Supply Fan 1 Power Output
Analog	102	Sf2_kW	kilowatts	40103	R	Supply Fan 2 Power Output
Analog	103	Sf3_kW	kilowatts	40104	R	Supply Fan 3 Power Output
Analog	104	Sf4_kW	kilowatts	40105	R	Supply Fan 4 Power Output
Analog	111	Ef1_FrRe	hertz	40112	R	Exhaust Fan 1 Frequency Reference
Analog	112	Ef2_FrRe	hertz	40113	R	Exhaust Fan 2 Frequency Reference
Analog	113	Ef3_FrRe	hertz	40114	R	Exhaust Fan 3 Frequency Reference
Analog	114	Ef4_FrRe	hertz	40115	R	Exhaust Fan 4 Frequency Reference
Analog	115	Ef5_FrRe	hertz	40116	R	Exhaust Fan 5 Frequency Reference
Analog	116	Ef6_FrRe	hertz	40117	R	Exhaust Fan 6 Frequency Reference
Analog	117	Ef7_FrRe	hertz	40118	R	Exhaust Fan 7 Frequency Reference
Analog	118	Ef8_FrRe	hertz	40119	R	Exhaust Fan 8 Frequency Reference
Analog	119	Ef9_FrRe	hertz	40120	R	Exhaust Fan 9 Frequency Reference
Analog	120	Ef10_FrRe	hertz	40121	R	Exhaust Fan 10 Frequency Reference
Analog	131	Sf1_FrRe	hertz	40132	R	Supply Fan 1 Frequency Reference
Analog	132	Sf2_FrRe	hertz	40133	R	Supply Fan 2 Frequency Reference
Analog	133	Sf3_FrRe	hertz	40134	R	Supply Fan 3 Frequency Reference
Analog	134	Sf4_FrRe	hertz	40135	R	Supply Fan 4 Frequency Reference
Analog	141	Ef1_LoTemp	°F	40142	R/W	Exhaust Fan 1 Low Temperature Setting
Analog	142	Ef2_LoTemp	°F	40143	R/W	Exhaust Fan 2 Low Temperature Setting
Analog	143	Ef3_LoTemp	°F	40144	R/W	Exhaust Fan 3 Low Temperature Setting
Analog	144	Ef4_LoTemp	°F	40145	R/W	Exhaust Fan 4 Low Temperature Setting
Analog	145	EF5_LoTemp	°F	40146	R/W	Exhaust Fan 5 Low Temperature Setting
Analog	146	EF6_LoTemp	°F	40147	R/W	Exhaust Fan 6 Low Temperature Setting
Analog	147	EF7_LoTemp	°F	40148	R/W	Exhaust Fan 7 Low Temperature Setting
Analog	148	EF8_LoTemp	°F	40149	R/W	Exhaust Fan 8 Low Temperature Setting



## BMS Points List • ASCP v2.00 Modbus / BACnet®

Type	BACnet Device Instance: 77000 (default) Analog = AV, Integer = AV, Digital = BV				Modbus - RTU/TCP Address: 1 (default)	Read Write	Description
	Instance	Name	Units		Register		
Analog	149	Ef9_LoTemp	°F		40150	R/W	Exhaust Fan 9 Low Temperature Setting
Analog	150	Ef10_LoTemp	°F		40151	R/W	Exhaust Fan 10 Low Temperature Setting
Analog	151	Ef1_HiTemp	°F		40152	R/W	Exhaust Fan 1 High Temperature Setting
Analog	152	Ef2_HiTemp	°F		40153	R/W	Exhaust Fan 2 High Temperature Setting
Analog	153	Ef3_HiTemp	°F		40154	R/W	Exhaust Fan 3 High Temperature Setting
Analog	154	Ef4_HiTemp	°F		40155	R/W	Exhaust Fan 4 High Temperature Setting
Analog	155	Ef5_HiTemp	°F		40156	R/W	Exhaust Fan 5 High Temperature Setting
Analog	156	Ef6_HiTemp	°F		40157	R/W	Exhaust Fan 6 High Temperature Setting
Analog	157	Ef7_HiTemp	°F		40158	R/W	Exhaust Fan 7 High Temperature Setting
Analog	158	Ef8_HiTemp	°F		40159	R/W	Exhaust Fan 8 High Temperature Setting
Analog	159	Ef9_HiTemp	°F		40160	R/W	Exhaust Fan 9 High Temperature Setting
Analog	160	Ef10_HiTemp	°F		40161	R/W	Exhaust Fan 10 High Temperature Setting
Analog	161	Ef1_LoSpeed	percent		40162	R/W	Exhaust Fan 1 Low Speed Setting
Analog	162	Ef2_LoSpeed	percent		40163	R/W	Exhaust Fan 2 Low Speed Setting
Analog	163	Ef3_LoSpeed	percent		40164	R/W	Exhaust Fan 3 Low Speed Setting
Analog	164	Ef4_LoSpeed	percent		40165	R/W	Exhaust Fan 4 Low Speed Setting
Analog	165	Ef5_LoSpeed	percent		40166	R/W	Exhaust Fan 5 Low Speed Setting
Analog	166	Ef6_LoSpeed	percent		40167	R/W	Exhaust Fan 6 Low Speed Setting
Analog	167	Ef7_LoSpeed	percent		40168	R/W	Exhaust Fan 7 Low Speed Setting
Analog	168	Ef8_LoSpeed	percent		40169	R/W	Exhaust Fan 8 Low Speed Setting
Analog	169	Ef9_LoSpeed	percent		40170	R/W	Exhaust Fan 9 Low Speed Setting
Analog	170	Ef10_LoSpeed	percent		40171	R/W	Exhaust Fan 10 Low Speed Setting
Analog	171	Ef1_HiSpeed	percent		40172	R/W	Exhaust Fan 1 High Speed Setting
Analog	172	Ef2_HiSpeed	percent		40173	R/W	Exhaust Fan 2 High Speed Setting
Analog	173	Ef3_HiSpeed	percent		40174	R/W	Exhaust Fan 3 High Speed Setting
Analog	174	Ef4_HiSpeed	percent		40175	R/W	Exhaust Fan 4 High Speed Setting
Analog	175	Ef5_HiSpeed	percent		40176	R/W	Exhaust Fan 5 High Speed Setting
Analog	176	Ef6_HiSpeed	percent		40177	R/W	Exhaust Fan 6 High Speed Setting
Analog	177	Ef7_HiSpeed	percent		40178	R/W	Exhaust Fan 7 High Speed Setting
Analog	178	Ef8_HiSpeed	percent		40179	R/W	Exhaust Fan 8 High Speed Setting
Analog	179	Ef9_HiSpeed	percent		40180	R/W	Exhaust Fan 9 High Speed Setting
Analog	180	Ef10_HiSpeed	percent		40181	R/W	Exhaust Fan 10 High Speed Setting
Analog	181	Sf1_LoSpeed	percent		40182	R/W	Supply Fan 1 Low Speed Setting
Analog	182	Sf2_LoSpeed	percent		40183	R/W	Supply Fan 2 Low Speed Setting
Analog	183	Sf3_LoSpeed	percent		40184	R/W	Supply Fan 3 Low Speed Setting
Analog	184	Sf4_LoSpeed	percent		40185	R/W	Supply Fan 4 Low Speed Setting
Analog	191	Sf1_HiSpeed	percent		40192	R/W	Supply Fan 1 High Speed Setting
Analog	192	Sf2_HiSpeed	percent		40193	R/W	Supply Fan 2 High Speed Setting
Analog	193	Sf3_HiSpeed	percent		40194	R/W	Supply Fan 3 High Speed Setting
Analog	194	Sf4_HiSpeed	percent		40195	R/W	Supply Fan 4 High Speed Setting
Integer	1011	Ef1_Speed	percent		40220	R	Exhaust Fan 1 Speed Percentage
Integer	1012	Ef2_Speed	percent		40221	R	Exhaust Fan 2 Speed Percentage
Integer	1013	Ef3_Speed	percent		40222	R	Exhaust Fan 3 Speed Percentage
Integer	1014	Ef4_Speed	percent		40223	R	Exhaust Fan 4 Speed Percentage
Integer	1015	Ef5_Speed	percent		40224	R	Exhaust Fan 5 Speed Percentage
Integer	1016	Ef6_Speed	percent		40225	R	Exhaust Fan 6 Speed Percentage
Integer	1017	Ef7_Speed	percent		40226	R	Exhaust Fan 7 Speed Percentage
Integer	1018	Ef8_Speed	percent		40227	R	Exhaust Fan 8 Speed Percentage
Integer	1019	Ef9_Speed	percent		40228	R	Exhaust Fan 9 Speed Percentage
Integer	1020	Ef10_Speed	percent		40229	R	Exhaust Fan 10 Speed Percentage
Integer	1031	Sf1_Speed	percent		40240	R	Supply Fan 1 Speed Percentage
Integer	1032	Sf2_Speed	percent		40241	R	Supply Fan 2 Speed Percentage
Integer	1033	Sf3_Speed	percent		40242	R	Supply Fan 3 Speed Percentage
Integer	1034	Sf4_Speed	percent		40243	R	Supply Fan 4 Speed Percentage
			Inactive_Text	Active_Text			
Digital	10	GLOBAL_ALARM	Off	Alarm	10011	R	Global Alarm
Digital	11	Sys1_On_Off	Off	On	10012	R/W	Hood System 1 On/Off (0: Off; 1: On)
Digital	12	Sys2_On_Off	Off	On	10013	R/W	Hood System 2 On/Off (0: Off; 1: On)
Digital	13	Sys3_On_Off	Off	On	10014	R/W	Hood System 3 On/Off (0: Off; 1: On)
Digital	14	Sys4_On_Off	Off	On	10015	R/W	Hood System 4 On/Off (0: Off; 1: On)



## BMS Points List • ASCP v2.00 Modbus / BACnet®

Type	BACnet Device Instance: 77000 (default) Analog = AV, Integer = AV, Digital = BV				Modbus - RTU/TCP Address: 1 (default)	Read Write	Description
	Instance	Name	Units		Register		
Digital	15	Sys5_On_Off	Off	On	10016	R/W	Hood System 5 On/Off (0: Off; 1: On)
Digital	16	Sys6_On_Off	Off	On	10017	R/W	Hood System 6 On/Off (0: Off; 1: On)
Digital	17	Sys7_On_Off	Off	On	10018	R/W	Hood System 7 On/Off (0: Off; 1: On)
Digital	18	Sys8_On_Off	Off	On	10019	R/W	Hood System 8 On/Off (0: Off; 1: On)
Digital	19	Sys9_On_Off	Off	On	10020	R/W	Hood System 9 On/Off (0: Off; 1: On)
Digital	20	Sys10_On_Off	Off	On	10021	R/W	Hood System 10 On/Off (0: Off; 1: On)
Digital	91	T1_Alm	Off	Alarm	10092	R	Temp Sensor 1 Failure
Digital	92	T2_Alm	Off	Alarm	10093	R	Temp Sensor 2 Failure
Digital	93	T3_Alm	Off	Alarm	10094	R	Temp Sensor 3 Failure
Digital	94	T4_Alm	Off	Alarm	10095	R	Temp Sensor 4 Failure
Digital	95	T5_Alm	Off	Alarm	10096	R	Temp Sensor 5 Failure
Digital	96	T6_Alm	Off	Alarm	10097	R	Temp Sensor 6 Failure
Digital	97	T7_Alm	Off	Alarm	10098	R	Temp Sensor 7 Failure
Digital	98	T8_Alm	Off	Alarm	10099	R	Temp Sensor 8 Failure
Digital	99	T9_Alm	Off	Alarm	10100	R	Temp Sensor 9 Failure
Digital	100	T10_Alm	Off	Alarm	10101	R	Temp Sensor 10 Failure
Digital	101	Fire_Alm	Off	Alarm	10102	R	Fire System Status (0: Ok; 1: Fire)
Digital	102	Rem_En	Off	On	10103	R/W	Remote Enable (0: Off; 1: On)
Digital	103	Wash_En	Off	On	10104	R/W	Wash Enable (0: Off; 1: On)
Digital	104	Fill_det	Off	Alarm	10105	R	Detergent Status (0: Ok; 1: Empty)
Digital	105	CWM_status	Off	On	10106	R	Cold Water Mist Status (0: Off; 1: On)
Digital	106	PCU_filter_1	Off	Alarm	10107	R	PCU Filter 1 Status (0: Ok; 1: Clogged)
Digital	107	PCU_filter_2	Off	Alarm	10108	R	PCU Filter 2 Status (0: Ok; 1: Clogged)
Digital	108	PCU_filter_3	Off	Alarm	10109	R	PCU Filter 3 Status (0: Ok; 1: Clogged)
Digital	131	Sf1_Af_Alm	Off	Alarm	10132	R	Airflow Alarm Supply Fan 1
Digital	132	Sf2_Af_Alm	Off	Alarm	10133	R	Airflow Alarm Supply Fan 2
Digital	133	Sf3_Af_Alm	Off	Alarm	10134	R	Airflow Alarm Supply Fan 3
Digital	134	Sf4_Af_Alm	Off	Alarm	10135	R	Airflow Alarm Supply Fan 4
Digital	141	Sf1_Pres_Alm	Off	Alarm	10142	R	Supply Fan 1 Pressure Alarm
Digital	160	HiTemp_Alm	Off	Alarm	10161	R	High Temperature Alarm
Digital	161	Exh_BO_Alm	Off	Alarm	10162	R	Exhaust Starter/VFD Fault
Digital	162	Sup_BO_Alm	Off	Alarm	10163	R	Supply Starter/VFD Fault
Digital	163	Exh_VBF_Alm	Off	Alarm	10164	R	Exhaust VFD By Factory Fault
Digital	164	Sup_VBF_Alm	Off	Alarm	10165	R	Supply VFD By Factory Fault
Digital	171	Ef1_Status	Off	On	10172	R	Exhaust Fan 1 Status
Digital	172	Ef2_Status	Off	On	10173	R	Exhaust Fan 2 Status
Digital	173	Ef3_Status	Off	On	10174	R	Exhaust Fan 3 Status
Digital	174	Ef4_Status	Off	On	10175	R	Exhaust Fan 4 Status
Digital	175	Ef5_Status	Off	On	10176	R	Exhaust Fan 5 Status
Digital	176	Ef6_Status	Off	On	10177	R	Exhaust Fan 6 Status
Digital	177	Ef7_Status	Off	On	10178	R	Exhaust Fan 7 Status
Digital	178	Ef8_Status	Off	On	10179	R	Exhaust Fan 8 Status
Digital	179	Ef9_Status	Off	On	10180	R	Exhaust Fan 9 Status
Digital	180	Ef10_Status	Off	On	10181	R	Exhaust Fan 10 Status
Digital	181	Sf1_Status	Off	On	10182	R	Supply Fan 1 Status
Digital	182	Sf2_Status	Off	On	10183	R	Supply Fan 2 Status
Digital	183	Sf3_Status	Off	On	10184	R	Supply Fan 3 Status
Digital	184	Sf4_Status	Off	On	10185	R	Supply Fan 3 Status



## BMS Points List • ASCP v2.00 LonWorks®

Type	NV_Index/Bit	Name NV	Type NV	Read (Unit to BMS) Write (BMS to Unit)	Description
Analog	15	nvoH1_Ctemp	105	Read	Hood 1 Control Temperature
Analog	16	nvoH2_Ctemp	105	Read	Hood 2 Control Temperature
Analog	17	nvoH3_Ctemp	105	Read	Hood 3 Control Temperature
Analog	18	nvoH4_Ctemp	105	Read	Hood 4 Control Temperature
Analog	19	nvoH5_Ctemp	105	Read	Hood 5 Control Temperature
Analog	20	nvoH6_Ctemp	105	Read	Hood 6 Control Temperature
Analog	21	nvoH7_Ctemp	105	Read	Hood 7 Control Temperature
Analog	22	nvoH8_Ctemp	105	Read	Hood 8 Control Temperature
Analog	23	nvoH9_Ctemp	105	Read	Hood 9 Control Temperature
Analog	24	nvoH10_Ctemp	105	Read	Hood 10 Control Temperature
Integer	25	nvoEf1_Speed	81	Read	Exhaust Fan 1 Speed Percentage
Integer	26	nvoEf2_Speed	81	Read	Exhaust Fan 2 Speed Percentage
Integer	27	nvoEf3_Speed	81	Read	Exhaust Fan 3 Speed Percentage
Integer	28	nvoEf4_Speed	81	Read	Exhaust Fan 4 Speed Percentage
Integer	29	nvoEf5_Speed	81	Read	Exhaust Fan 5 Speed Percentage
Integer	30	nvoEf6_Speed	81	Read	Exhaust Fan 6 Speed Percentage
Integer	31	nvoEf7_Speed	81	Read	Exhaust Fan 7 Speed Percentage
Integer	32	nvoEf8_Speed	81	Read	Exhaust Fan 8 Speed Percentage
Integer	33	nvoEf9_Speed	81	Read	Exhaust Fan 9 Speed Percentage
Integer	34	nvoEf10_Speed	81	Read	Exhaust Fan 10 Speed Percentage
Integer	35	nvoSf1_Speed	81	Read	Supply Fan 1 Speed Percentage
Integer	36	nvoSf2_Speed	81	Read	Supply Fan 2 Speed Percentage
Integer	37	nvoSf3_Speed	81	Read	Supply Fan 3 Speed Percentage
Integer	38	nvoSf4_Speed	81	Read	Supply Fan 4 Speed Percentage
Digital	39	nvoGLOBAL_ALARM	81	Read	Global Alarm
Digital	3	nviSys1_On_Off	95	Write	Hood System 1 On/Off (0: Off; 1: On)
Digital	4	nviSys2_On_Off	95	Write	Hood System 2 On/Off (0: Off; 1: On)
Digital	5	nviSys3_On_Off	95	Write	Hood System 3 On/Off (0: Off; 1: On)
Digital	6	nviSys4_On_Off	95	Write	Hood System 4 On/Off (0: Off; 1: On)
Digital	7	nviSys5_On_Off	95	Write	Hood System 5 On/Off (0: Off; 1: On)
Digital	8	nviSys6_On_Off	95	Write	Hood System 6 On/Off (0: Off; 1: On)
Digital	9	nviSys7_On_Off	95	Write	Hood System 7 On/Off (0: Off; 1: On)
Digital	10	nviSys8_On_Off	95	Write	Hood System 8 On/Off (0: Off; 1: On)
Digital	11	nviSys9_On_Off	95	Write	Hood System 9 On/Off (0: Off; 1: On)
Digital	12	nviSys10_On_Off	95	Write	Hood System 10 On/Off (0: Off; 1: On)
Digital	13	Rem_En	95	Write	Remote Enable (0: Off; 1: On)
Digital	14	nviwash_En	95	Write	Wash Enable (0: Off; 1: On)
	40	nvoTmp_Snsr_Alms	83		Temperature Sensor Alarms
Digital	(LSB) bit0	T1_Alm		Read	Temp Sensor 1 Failure
Digital	bit1	T2_Alm		Read	Temp Sensor 2 Failure
Digital	bit2	T3_Alm		Read	Temp Sensor 3 Failure
Digital	bit3	T4_Alm		Read	Temp Sensor 4 Failure
Digital	bit4	T5_Alm		Read	Temp Sensor 5 Failure
Digital	bit5	T6_Alm		Read	Temp Sensor 6 Failure
Digital	bit6	T7_Alm		Read	Temp Sensor 7 Failure
Digital	bit7	T8_Alm		Read	Temp Sensor 8 Failure
Digital	bit8	T9_Alm		Read	Temp Sensor 9 Failure
Digital	bit9	T10_Alm		Read	Temp Sensor 10 Failure
Digital	41	Fire_Alm	95	Read	Fire System Status (0: Ok; 1: Fire)
Digital	42	nvoFill_det	95	Read	Detergent Status (0: Ok; 1: Empty)
Digital	43	nvoCWM_status	95	Read	Cold Water Mist Status (0: Off; 1: On)



**BMS Points List • ASCP v2.00 LonWorks®**

Type	NV_Index/Bit	Name NV	Type NV	Read (Unit to BMS) Write (BMS to Unit)	Description
	44	nvoPCU_FilterAlm	83		PCU Filter Alarms
Digital	(LSB) bit0	PCU_filter_1		Read	PCU Filter 1 Status (0: Ok; 1: Clogged)
Digital	bit1	PCU_filter_2		Read	PCU Filter 2 Status (0: Ok; 1: Clogged)
Digital	bit2	PCU_filter_3		Read	PCU Filter 3 Status (0: Ok; 1: Clogged)
Digital	45	Sf1_Pres_Alm		Read	Supply Fan 1 Pressure Alarm
Digital	46	nvoHiTemp_Alm	95	Read	High Temperature Alarm
	47	nvoAirProvAlms	83		Supply Airflow Proving Alarms
Digital	(LSB) bit0	Sf1_Af_Alm		Read	Airflow Alarm Supply Fan 1
Digital	bit1	Sf2_Af_Alm		Read	Airflow Alarm Supply Fan 2
Digital	bit2	Sf3_Af_Alm		Read	Airflow Alarm Supply Fan 3
Digital	bit3	Sf4_Af_Alm		Read	Airflow Alarm Supply Fan 4
	48	nvoVFDAlms	83		Supply Airflow Proving Alarms
Digital	(LSB) bit0	Exh_BO_Alm		Read	Exhaust Starter/VFD Fault
Digital	bit1	Sup_BO_Alm		Read	Supply Starter/VFD Fault
Digital	bit2	Exh_VBF_Alm		Read	Exhaust VFD By Factory Fault
Digital	bit3	Sup_VBF_Alm		Read	Supply VFD By Factory Fault
	49	nvoEF_Status	83		Exhaust Fans Status
Digital	(LSB) bit0	Ef1_Status		Read	Exhaust Fan 1 Status
Digital	bit1	Ef2_Status		Read	Exhaust Fan 2 Status
Digital	bit2	Ef3_Status		Read	Exhaust Fan 3 Status
Digital	bit3	Ef4_Status		Read	Exhaust Fan 4 Status
Digital	bit4	Ef5_Status		Read	Exhaust Fan 5 Status
Digital	bit5	Ef6_Status		Read	Exhaust Fan 6 Status
Digital	bit6	Ef7_Status		Read	Exhaust Fan 7 Status
Digital	bit7	Ef8_Status		Read	Exhaust Fan 8 Status
Digital	bit8	Ef9_Status		Read	Exhaust Fan 9 Status
Digital	bit9	Ef10_Status		Read	Exhaust Fan 10 Status
	50	nvoSF_Status	83		Supply Fans Status
Digital	(LSB) bit0	Sf1_Status		Read	Supply Fan 1 Status
Digital	bit1	Sf2_Status		Read	Supply Fan 2 Status
Digital	bit2	Sf3_Status		Read	Supply Fan 3 Status
Digital	bit3	Sf4_Status		Read	Supply Fan 4 Status



# Maintenance Log

Date \_\_\_\_\_ Time \_\_\_\_\_ AM/PM  
Notes: \_\_\_\_\_

\_\_\_\_\_  
\_\_\_\_\_  
\_\_\_\_\_

Date \_\_\_\_\_ Time \_\_\_\_\_ AM/PM  
Notes: \_\_\_\_\_

\_\_\_\_\_  
\_\_\_\_\_  
\_\_\_\_\_

Date \_\_\_\_\_ Time \_\_\_\_\_ AM/PM  
Notes: \_\_\_\_\_

\_\_\_\_\_  
\_\_\_\_\_  
\_\_\_\_\_

Date \_\_\_\_\_ Time \_\_\_\_\_ AM/PM  
Notes: \_\_\_\_\_

\_\_\_\_\_  
\_\_\_\_\_  
\_\_\_\_\_

Date \_\_\_\_\_ Time \_\_\_\_\_ AM/PM  
Notes: \_\_\_\_\_

\_\_\_\_\_  
\_\_\_\_\_  
\_\_\_\_\_

Date \_\_\_\_\_ Time \_\_\_\_\_ AM/PM  
Notes: \_\_\_\_\_

\_\_\_\_\_  
\_\_\_\_\_  
\_\_\_\_\_

Date \_\_\_\_\_ Time \_\_\_\_\_ AM/PM  
Notes: \_\_\_\_\_

\_\_\_\_\_  
\_\_\_\_\_  
\_\_\_\_\_

Date \_\_\_\_\_ Time \_\_\_\_\_ AM/PM  
Notes: \_\_\_\_\_

\_\_\_\_\_  
\_\_\_\_\_  
\_\_\_\_\_

Date \_\_\_\_\_ Time \_\_\_\_\_ AM/PM  
Notes: \_\_\_\_\_

\_\_\_\_\_  
\_\_\_\_\_  
\_\_\_\_\_

Date \_\_\_\_\_ Time \_\_\_\_\_ AM/PM  
Notes: \_\_\_\_\_

\_\_\_\_\_  
\_\_\_\_\_  
\_\_\_\_\_

Date \_\_\_\_\_ Time \_\_\_\_\_ AM/PM  
Notes: \_\_\_\_\_

\_\_\_\_\_  
\_\_\_\_\_  
\_\_\_\_\_

Date \_\_\_\_\_ Time \_\_\_\_\_ AM/PM  
Notes: \_\_\_\_\_

\_\_\_\_\_  
\_\_\_\_\_  
\_\_\_\_\_

Date \_\_\_\_\_ Time \_\_\_\_\_ AM/PM  
Notes: \_\_\_\_\_

\_\_\_\_\_  
\_\_\_\_\_  
\_\_\_\_\_

Date \_\_\_\_\_ Time \_\_\_\_\_ AM/PM  
Notes: \_\_\_\_\_

\_\_\_\_\_  
\_\_\_\_\_  
\_\_\_\_\_

# Maintenance Log

Date \_\_\_\_\_ Time \_\_\_\_\_ AM/PM  
Notes: \_\_\_\_\_

\_\_\_\_\_  
\_\_\_\_\_  
\_\_\_\_\_

Date \_\_\_\_\_ Time \_\_\_\_\_ AM/PM  
Notes: \_\_\_\_\_

\_\_\_\_\_  
\_\_\_\_\_  
\_\_\_\_\_

Date \_\_\_\_\_ Time \_\_\_\_\_ AM/PM  
Notes: \_\_\_\_\_

\_\_\_\_\_  
\_\_\_\_\_  
\_\_\_\_\_

Date \_\_\_\_\_ Time \_\_\_\_\_ AM/PM  
Notes: \_\_\_\_\_

\_\_\_\_\_  
\_\_\_\_\_  
\_\_\_\_\_

Date \_\_\_\_\_ Time \_\_\_\_\_ AM/PM  
Notes: \_\_\_\_\_

\_\_\_\_\_  
\_\_\_\_\_  
\_\_\_\_\_

Date \_\_\_\_\_ Time \_\_\_\_\_ AM/PM  
Notes: \_\_\_\_\_

\_\_\_\_\_  
\_\_\_\_\_  
\_\_\_\_\_

Date \_\_\_\_\_ Time \_\_\_\_\_ AM/PM  
Notes: \_\_\_\_\_

\_\_\_\_\_  
\_\_\_\_\_  
\_\_\_\_\_

Date \_\_\_\_\_ Time \_\_\_\_\_ AM/PM  
Notes: \_\_\_\_\_

\_\_\_\_\_  
\_\_\_\_\_  
\_\_\_\_\_

Date \_\_\_\_\_ Time \_\_\_\_\_ AM/PM  
Notes: \_\_\_\_\_

\_\_\_\_\_  
\_\_\_\_\_  
\_\_\_\_\_

Date \_\_\_\_\_ Time \_\_\_\_\_ AM/PM  
Notes: \_\_\_\_\_

\_\_\_\_\_  
\_\_\_\_\_  
\_\_\_\_\_

Date \_\_\_\_\_ Time \_\_\_\_\_ AM/PM  
Notes: \_\_\_\_\_

\_\_\_\_\_  
\_\_\_\_\_  
\_\_\_\_\_

Date \_\_\_\_\_ Time \_\_\_\_\_ AM/PM  
Notes: \_\_\_\_\_

\_\_\_\_\_  
\_\_\_\_\_  
\_\_\_\_\_

Date \_\_\_\_\_ Time \_\_\_\_\_ AM/PM  
Notes: \_\_\_\_\_

\_\_\_\_\_  
\_\_\_\_\_  
\_\_\_\_\_

Date \_\_\_\_\_ Time \_\_\_\_\_ AM/PM  
Notes: \_\_\_\_\_

\_\_\_\_\_  
\_\_\_\_\_  
\_\_\_\_\_



## Our Commitment

---

*As a result of our commitment to continuous improvement, Accurex reserves the right to change specifications without notice.*

Specific Accurex product warranties are located on [accurex.com](http://accurex.com) within the product area tabs and in the Library under Warranties.



P.O. Box 410 Schofield, WI 54476  
Phone: 800.333.1400 • Fax: 715.241.6191  
Parts: 800.355.5354 • [www.accurex.com](http://www.accurex.com)