

Installation, Operation and Maintenance Manual

Please read and save these instructions for future reference. Read carefully before attempting to assemble, install, operate or maintain the product described. Protect yourself and others by observing all safety information. Failure to comply with instructions could result in personal injury and/or property damage!

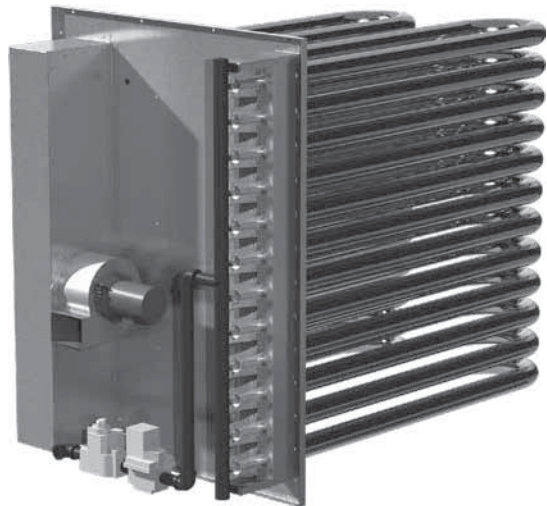

Model XPVF(-H)

Recognized Component

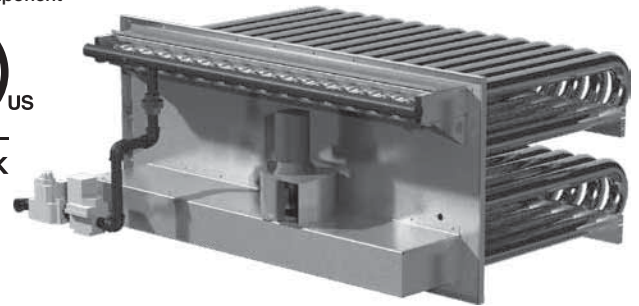

Model XPVG

General Safety Information

These indirect gas-fired furnaces are commonly used in many different manufacturer's ventilating products. For unit-specific information, refer to the Installation, Operation and Maintenance manual (IOM) for the unit in which this furnace is installed.

- Both the furnace units are listed for installation in the United States and in Canada.
- Installation of gas-fired duct furnaces must conform with local building codes. In the absence of local building codes, installation must conform to the National Fuel Gas code, ANSI Z223.1 or in Canada, CAN/CGA-B149 Installation codes.
- All electrical wiring must be in accordance with the regulations of the National Electric Code, ANSI/NFPA-70.
- Unit is approved for installation downstream from refrigeration units. In these conditions, condensate could form in the duct furnace and provision must be made to dispose of the condensate.

WARNING

FIRE OR EXPLOSION HAZARD

Failure to follow safety warnings exactly could result in serious injury, death or property damage.

Be sure to read and understand the installation, operation and service instructions in this manual.

Improper installation, adjustment alteration, service or maintenance can cause serious injury, death or property damages.

- Do not store or use gasoline or other flammable vapors and liquids in the vicinity of this or any other appliance.
- WHAT TO DO IF YOU SMELL GAS
 - Do not try to light any appliance.
 - Do not touch any electrical switch; do not use any phone in your building.
 - Leave the building immediately.
 - Immediately call your gas supplier from a phone remote from the building. Follow the gas supplier's instructions.
 - If you cannot reach your gas supplier, call the fire department.
- Installation and service must be performed by a qualified installer, service agency or the gas supplier.

NOTE

Models XPVF(-H) and XPVG are indirect gas-fired heat modules that will be referred to in this manual as a furnace.

Receiving

Upon receiving the product, check to ensure all items are accounted for by referencing the delivery receipt or packing list. Inspect each crate or carton for shipping damage before accepting delivery. Alert the carrier of any damage detected. The customer will make notation of damage (or shortage of items) on the delivery receipt and all copies of the bill of lading which is countersigned by the delivering carrier. If damaged, immediately contact your manufacturer's representative. Any physical damage to the unit after acceptance is not the responsibility of the manufacturer.

Unpacking

If unit is to be installed, tested and operated right away, locate and remove all packing materials from the furnace, including any protective coverings that may be on the combustion air intake and on the furnace exhaust. Follow *Unpacking Instructions* as found in the unit-specific IOM.

Storage

If unit must be stored after it is received, take steps to protect furnace from damage, moisture, and extreme temperatures. Verify that gas piping is plugged.

Unit Identification

It is necessary to know the unit model number, the burner control turndown and the serial number. This information is needed when ordering replacement parts and is available on labels located on the unit.

Furnace Model Number

On the furnace access door or immediately next to the door is a Mylar data label. See image below. Locate the furnace model number at the top of the label and record it here:

Furnace Model Number: _____

Model Number	MODEL NUMBER NUMERO DO MODELO XPVF150H			
	TYPE OF GAS TYPE DE GAZ	NATURAL	TEMPERATURE RISE RANGE ELEVATION DE TEMPERATURE	20-100 °F
Minimum Input BTU/HR	MAXIMUM EXTERNAL STATIC PRESSURE PRESSION STATIQUE MAXIMUM	3 IN W.C. P.O.C.C.B.	MANIFOLD PRESSURE PRESSION ALA TUBULURE CALIBRATION	3.5 IN W.C. P.O.C.C.B.
Input BTU/HR	MINIMUM INPUT DEBIT CALORIFIQUE MINIMUM BTU/HEURE	75,000	MINIMUM GAS SUPPLY PRESSURE PRESSION MINIMALE D'ALIMENTATION DU GAZ	6 IN W.C. P.O.C.C.B.
	INPUT BTU/HR DEBIT CALORIFIQUE BTU/HEURE	150,000	(IN CANADA) 2000 TO 4000 FEET 800 ET 1200 M	AIR THROUGHPUT DEBIT D'AIR
	OUTPUT BTU/HR RENDEMENT BTU/HEURE	120,000	135,000	1111 MAX CFM
	ORIFICE SIZE DIM DE L'ORIFICE	41	43	5556 MAX CFM
	115/208-230/460	60	1	1,2/0,6/0,3
	VOLTS	HERTZ	PHASE	AMPERE

Typical Furnace Data Label

Burner Control Turndown

Burner turndown ratio is used in many places and must be calculated. On the data label, locate the INPUT BTU/HR (the largest number on the label) and also the MINIMUM INPUT BTU/HR. Calculate the burner turndown ratio and record it.

$$\frac{\text{INPUT BTU/HR}}{\text{MINIMUM INPUT BTU/HR}} = \text{Burner Control Turndown Ratio}$$

Example: $\frac{150,000}{75,000} = 2$

The turndown ratio is 2:1 in this example.

Burner Turndown: _____

Furnace Serial Number

On the furnace access door is a plate identifying the unit serial number. Record that information here.

Furnace/Unit Serial Number: _____

ETL Listing

Model XPVF(-H) and XPVG furnaces have been ETL tested as gas-fired heat modules intended for installation as a component within heating equipment in duct or cabinet mounted applications. **They are ETL Recognized Components.**

Model XPVF(-H) furnaces have been ETL tested as duct furnaces intended for installation on the positive pressure side of an air circulation blower. **They are ETL Listed units.**

Product Overview

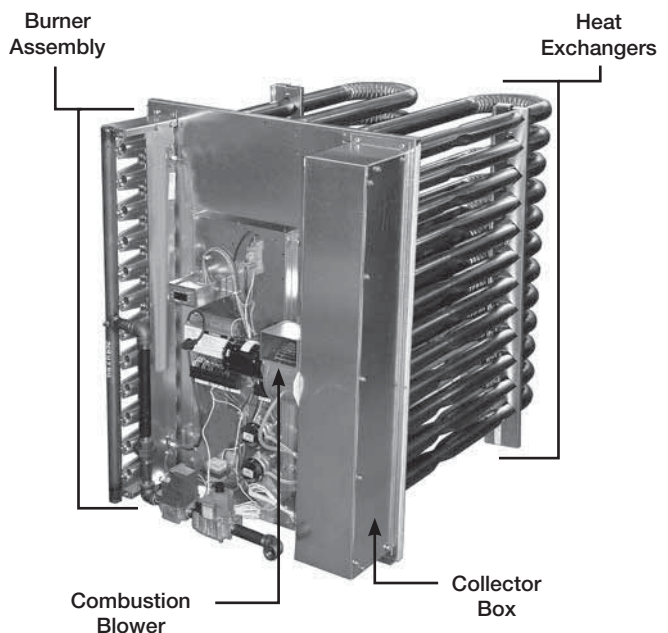

Table of Contents

General Safety Information	1	Performance Data	14
Receiving, Unpacking, Storage	2	Start-Up - Furnaces (all units)	15
Unit Identification	2	4:1 Turndown Electronic Modulation	15
Furnace Model Number	2	Adjust High Fire and Low Fire Settings	16
Burner Control Turndown	2	Modulating Valve High Fire Setting	16
Furnace Serial Number	2	Modulating Valve Low Fire Setting	16
ETL Listing	2	With High Turndown Electronic Modulation	17
Product Overview	2	8 Stage Combustion	18
Furnace Control Center		Single Stage	18
Furnace Control Center Components	4	2 Stage Combustion	19
Typical Furnace Control Logic	4	Combination Turndown Configurations	19
Typical Furnace, Electrical and		Troubleshooting	
Control Components	5	Ignition Controller	20
Gas-Fired Burner Turndown	6	4:1 Modulating with Stand-Alone Controller	21-25
Electronic Modulation	6	4:1 Modulating with Microprocessor Controller	26-29
Two Stage Valve	6	8 Stage with Stand-Alone Controller	30-33
Combinations	6	Single and Two Stage	34-36
Available Turndown Control Options	6	Reference: Controls	
Installation of Venting for Outdoor Units	7	Furnace Control with Microprocessor	37
Installation of Venting for Indoor Units	7	Maintenance	
Venting Methods	8	Combustion Blower Motor	38
Installation of Standard Indoor Venting		Burners and Orifices	38
Horizontal	8	Heat Exchanger	38
Vertical	8	Flue Collector Box	38
Installation of Concentric Venting		Electrical Wiring	38
Horizontal	9-10	Gas Train	38
Vertical	10-11	Replacement Parts	38
Two-Pipe Venting - Horizontal	11	Maintenance Log	39
Two-Pipe Venting - Vertical	12	Our Commitment	Backcover
Installation of Control Wiring	12		
Installation of Discharge Air Sensor	12		
Installation of Gas Piping	13		
Gas Supply Requirements	13		
Connect the Supply Gas Line	13		
Installation Addition Regulator	13		
Testing the System for Leaks	13		
Gas Pressure Test Ports	13		
Sequence of Operation	14		
Start-Up / Standby	14		
Heat Mode	14		
Recovery from Lockout	14		



Furnace Control Center

Each ventilating unit containing one or more furnaces will have a furnace control center located on the furnace vest plate. The control center receives high voltage AC from the main unit control center and in most cases, also receives low voltage control signals (call for heat) from the main unit control center. In all cases, see the unit-specific wiring schematic located inside the furnace door.

Furnace Control Center Components

(Components and their locations will vary.)

Components shown are for a typical 4:1 turndown electronic modulation configuration.

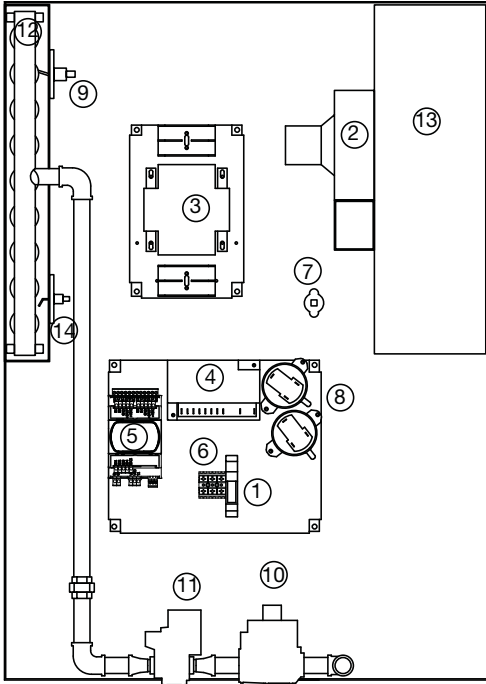

High Voltage Side

1. Inducer Relay (controls combustion fan)
2. Combustion Blower
3. Power Transformer

Low Voltage Side

4. Ignition Controller (also has high voltage present)
5. Furnace Controller (modulates heat and switches entire furnace on/off)
6. 24 volt Terminal Strip

Control Sensors

7. High Temperature Sensor (auto reset)
8. Airflow Switches
9. Flame Sensor

Gas Train

10. Combination Valve
11. Modulating Valve
12. Burner Manifold
13. Collector Box
14. Spark Rod

Typical Furnace Control Logic

In all cases, refer to the unit-specific wiring diagram located on the unit control center door.

This illustration is only for a typical 4:1 turndown electronic modulation configuration.

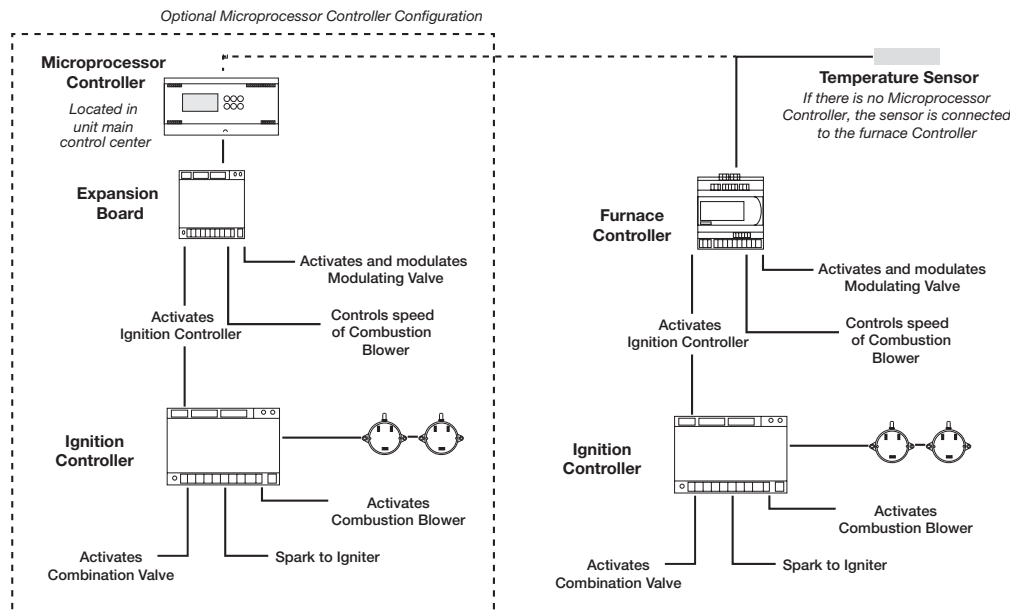

1. Microprocessor with pCOe (if present) or furnace controller senses low temperature from the temperature sensor, then sends an enable signal to the ignition controller, and 0-10 VDC signal to the modulating valve.
2. Ignition controller receives call for heat from pCOe expansion board or furnace controller, sends spark to igniter, and activates the combination valve. It looks for verification that the combustion blower is running.
3. Flame sensor detects flame and the trial for ignition ends.



Typical Furnace, Electrical and Control Components

Microprocessor

The microprocessor provides the call for heat to the ignition controller and also monitors the discharge air temperature. It is found in the unit's main control center. On units with electronic modulation, it also determines the required burner firing rate.



Discharge Air Temp Sensor

This sensor is shipped with all units and must be field-installed in the discharge air duct. This may be shipped in the main unit control center or in the furnace control center, depending on the control type.



pCOe Expansion Board

Used on all 4:1 or high turndown electronic modulating controls when a microprocessor controller is present in the unit.



The pCOe acts as an interface between the furnace and microprocessor controller. It sends the signal to enable the ignition controller, modulate the gas valve, speed up the combustion fan, and it monitors the furnace for alarms. The expansion board has no built-in logic since the main microprocessor controller contains the built-in logic.

Furnace Controller

Used on all stand-alone 4:1 electronic modulating controls and 8:1 staged controls.

The furnace controller provides power to the gas valve(s) and electronically adjusts the valve(s). It will also enable the ignition module. The furnace controller has a digital readout and six push buttons: Enter, Alarm, Program, Escape and arrows for Up or Down. It is pre-programmed at the factory for each specific furnace configuration and it may be used to control up to three furnaces at the same time.



Ignition Controller

This controller is found only in the furnace control center. It has an LED indicator light on the top right of the controller that will flash GREEN for normal operation or RED for an error. Some furnace configurations have two of these controllers.



Airflow Switch

Airflow switches are used on both furnaces and are found on the furnace vest plate. If the combustion blower is multi-speed, there will be two airflow switches and each will switch in response to a different pressure. The switch is connected to the combustion blower by means of a vacuum tube and is used to sense operation of the combustion blower. The internal switch is Normally Open (NO). If the blower fails to operate, the open circuit will cause the ignition controller to disable the furnace.



Flame Igniter

The igniter receives a high voltage input from the ignition controller to produce a spark between the two electrodes. It operates only during the ignition phase. On split burner manifolds, there will be two igniters.



Flame Sensor

The flame sensor is identical to the flame igniter. It is located on the opposite end of the burner manifold from the igniter. On split burner manifolds, there will be two flame sensors.

Auto Reset High Temperature Limit Switch

This limit switch is installed through the vest plate into the supply air plenum.



A350 and S350 Control System

Used on two stage and single stage controls. Used in conjunction with a discharge remote temperature sensor. Has an LED indicator light to show when the output relay is energized. When used with multiple stages, the S350 controller is used for the additional stages.



A350 Controller



S350 Controller

Burner Manifold



Single Section Burner Manifold



Split Burner Manifold

Gas-Fired Burner Turndown

Furnaces are available in single stage, multi-stage or electronically modulated configurations. In single stage, the entire furnace is either on or off. In multi-stage furnaces, combustion occurs in stages and is expressed as the number of different stages (example: 2 stage). Electronically modulated furnaces have continuously variable firing rates. In both staged and electronically modulated furnaces, the result is burner turndown. Turndown is the capability of the furnace to operate at less than full capacity, accomplished by reducing the amount of gas flow when the unit is operating. The advantage of turndown is that at partial-load conditions, the furnace will not cycle as often. Turndown is expressed as a ratio and is found by dividing the maximum BTU input by the minimum BTU input.

Electronic Modulation

The most common electronic modulation involves the use of an electronically-controlled gas valve which provides a 4:1 turndown. The entire furnace is sized appropriately for the maximum heat output ordered by the customer, but it can operate as low as 25% of its maximum capacity. The electronically-controlled gas valve will modulate the combustion rate continuously, dependent on the output from the furnace controller. With this method, all the burners fire at the same time but at a varying capacity. The Modulating Valve is used in conjunction with a furnace controller and a combination valve which provides an ON/OFF function.

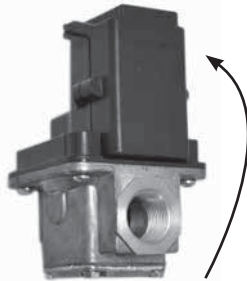

Low Fire and High Fire adjustments are made on printed circuit board behind removable cover

The high turndown option uses the same functionality as the 4:1 modulation described above in conjunction with a split manifold to provide higher turndown capabilities. When less heat is needed, a portion of the manifold is turned off and the remaining portion continues to modulate. This provides seamless modulation at very high turndown ratios. High turndown is classified as 8:1 turndown or greater per furnace.

Two Stage Valve

The two-stage valve is switched electrically from closed to full output to half output, producing a 2:1 turndown. In some cases, multiple furnaces may be used in a ventilating unit. When this is done with two single-stage furnaces, it is possible to run just one furnace at a time, resulting in a 2:1 turndown. If each furnace is already configured for a 2:1 turndown, the overall result can then be a 4:1 turndown.

Combinations

Various combinations of the methods outlined may be used to accomplish the turndown required by the application.

Available turndown control options include:

	Electronic Modulation
Single Furnace Unit	4:1 - uses modulating valve and furnace controller
	High turndown - uses 4:1 modulating valve with split manifold and furnace controller
Two Furnace Unit	8:1 - uses one 4:1 modulating furnace with furnace controller and one 2-stage furnace
	4:1 - uses two 4:1 modulating furnaces controlled in parallel
	High turndown furnaces in a series configuration - use one high turndown furnace and one 2-stage furnace
Three Furnace Unit	High turndown furnaces in a parallel configuration - use two high turndown furnaces, controlled in parallel
	12:1 - uses one 4:1 modulating furnace, one 2 stage furnace and one 1-stage furnace
Three Furnace Unit	High turndown - uses one high turndown furnace, one 2-stage furnace, and one 1-stage furnace

	Staged
Single Furnace Unit	8 stage
	2 stage
	1 stage
Two Furnace Unit	4-stage - uses two 2-stage furnaces
	2-stage - uses two single-stage furnaces
Three Furnace Unit	6-stage - uses three 2-stage furnaces
	3-stage - uses three 1-stage furnaces

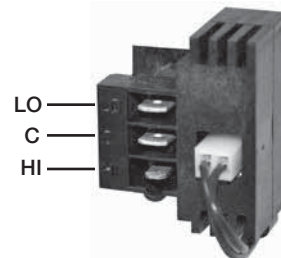
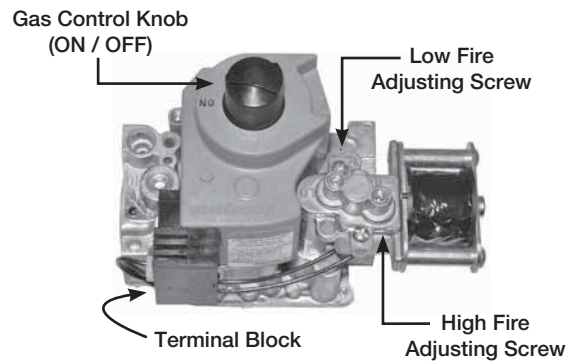

Close-up of Terminal Block
High fire terminal is the bottom of three terminals.



Installation of Venting for Outdoor Units

Follow Guidelines

All of the following guidelines must be followed when installing the unit.

WARNING

Do not install units in locations where flue products can be drawn into adjacent building openings such as windows, fresh air intakes, etc. Distance from vent terminal to adjacent public walkways, adjacent buildings, operable windows and building openings shall conform with the local codes. In the absence of local codes, installation shall conform with the National Fuel Gas Code, ANSI Z223.1 or the Canadian CAN/CGA B-149 Installation Codes.

WARNING

The following guidelines must be followed for all outdoor units:

1. Building materials that will be affected by flue gases should be protected.
2. Maintain minimum horizontal clearance of 4 feet from electric meters, gas meters, regulators and relief equipment. In Canada, the minimum clearance is 6 feet.
3. The combustion blower discharge on outdoor units must be located a minimum of 42 inches from any combustible materials.
4. Do not modify or obstruct the combustion air inlet cover or the combustion blower weatherhood.
5. Do not add vents other than those supplied by the manufacturer.
6. During the winter, keep the unit clear of snow to prevent any blockage of the combustion venting.

Install Stack (optional)

Clearance may require an exhaust stack. Install an exhaust stack as needed to the exhaust connection on the unit. Install a vent terminator on the exhaust pipe.

Exhaust transition and vent termination must be purchased from the factory for proper operation. Exhaust pipe is by others.

Installation of Venting for Indoor Units

WARNING

The following guidelines must be followed for all indoor units:

1. Installation of venting must conform with local building codes. In the absence of local codes, installation must conform with the National Fuel Gas Code, ANSI Z223.1 or in Canada, CAN/CGA-B149 installation codes.
2. For the exhaust pipe, use pipe approved for a Category III appliance or galvanized vent pipe sized 26 gauge or heavier. The piping is required to be gas-tight by ANSI.
3. For the combustion air pipe on separated combustion units, sealed single-wall galvanized air pipe is recommended.
4. The joints must be sealed with a metallic tape or Silastic™ suitable for temperatures up to 350°F.
5. A minimum of 12 inches of straight vent pipe is recommended after the exhaust connection and before any elbows.
6. Vertical combustion air pipes should be fitted with a tee, drip leg and clean-out cap to prevent any moisture in the combustion air pipe from entering the unit.
7. To reduce condensation, insulate any vent runs greater than 5 feet.
8. All vent pipe connections should be made with at least three corrosion-resistant sheet metal screws.
9. Refer to the National Fuel Gas Code for additional piping guidelines.

NOTE

Vent piping is supplied by others and not supplied by manufacturer.

NOTE

The drip leg should be cleaned out periodically during the heating season.

NOTE

Clearances from combustible material for indoor units are determined by the National Fuel Gas Code and/or other local codes.



Venting Methods

There are three venting methods for indoor mounted units. For each method, the units can be vented horizontally through an exterior wall or vertically through the roof. Specific venting instructions are provided for each method and shown in the following pages. Construct the vent system as shown in these instructions. Refer to your unit specific submittal to determine the applicable venting option.

The venting method options are:

Standard Indoor Venting

- uses building air for combustion
- vents exhaust to outdoors
- one exterior roof or wall penetration

Separated Combustion Concentric Venting

- uses outside air for combustion
- vents exhaust to outdoors
- one exterior roof or wall penetration

Separated Combustion 2-Pipe Venting

- uses outside air for combustion
- vents exhaust to outdoors
- two exterior roof or wall penetrations

NOTE

For each method, the units can be vented horizontally through an exterior wall or vertically through the roof. Refer to the specific venting instructions for your unit. Construct the vent system as shown in these instructions.

Installation of Standard Indoor Venting

Standard indoor venting uses one penetration through an exterior wall or roof for venting the flue exhaust. The combustion air is supplied from the air inside the building. Units must not be installed in a potentially explosive, flammable, or corrosive atmosphere. To prevent premature heat exchanger failure, do not locate unit where chlorinated, halogenated or acid vapors are present.

When units are installed in tightly sealed buildings, provisions should be made to supply an adequate amount of infiltration air from the outside. The rule of thumb is that an opening of one square inch should be provided for every 1000 BTUs per hour of input rating.

Vent terminals must be used. Construct the vent system as shown in the drawings. Reference the Vent Pipe Diameter table and Exhaust Vent Pipe table for additional details.

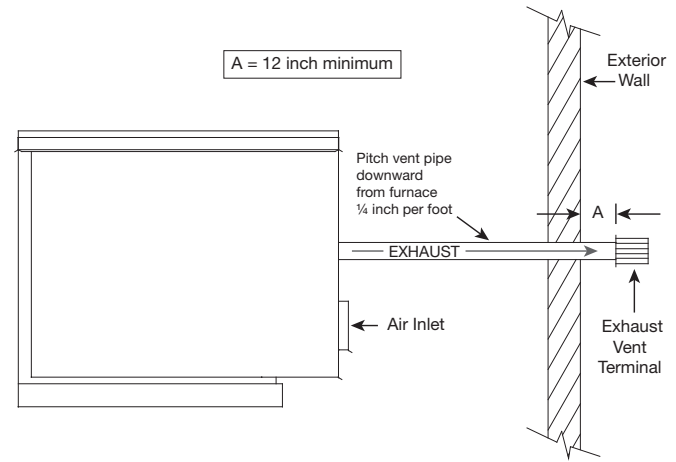

Standard Indoor Venting - Horizontal

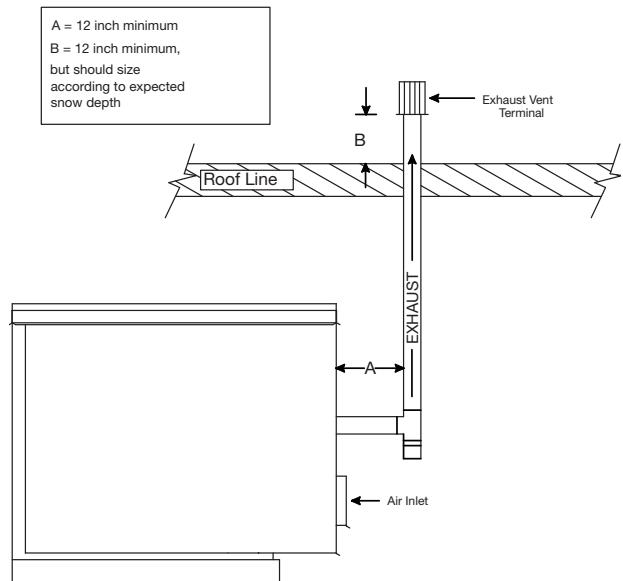

Standard Indoor Venting - Vertical

Vent Pipe Diameter

Select the vent pipe diameter. Use only the specified pipe diameter.

Standard Indoor Venting Vent Pipe Diameter	
Furnace Size (MBH)	Exhaust Pipe Diameter (inches)
75-175	4
200-400	6

Installing Exhaust Vent Pipe

Install the vent pipe with a minimum downward slope (from the unit) of 1/4-inch per foot (horizontal venting only). Securely suspend the pipe from overhead structures at points no greater than 3 feet apart.

The minimum vent length is 5 feet for horizontal and 10 feet for vertical.

The maximum vent length is 70 feet. The

total equivalent vent length must include elbows. The equivalent length of a 4 inch elbow is 6 feet and the equivalent length of a 6 inch elbow is 10 feet.

Attach the vent terminal to the end of the exhaust pipe.

Standard Indoor Venting Exhaust Vent Pipe		
Vent Length	Minimum (feet)	Maximum (feet)
Horizontal	5	70
Vertical	10	70



Installation of Concentric Venting

Concentric venting allows the exhaust pipe and combustion air pipe to pass through a single hole in the roof or wall of the building. A concentric venting adapter (CVA) is required for concentric venting.

The concentric venting adapter is designed for indoor installations and should never be installed on the exterior of the building.

The exhaust pipe must terminate with the vent terminal. For horizontal venting, the combustion air pipe must terminate with the combustion air guard. For vertical venting, the combustion air pipe must terminate with the inlet terminal. Depending on what was ordered, one of these vent terminals will be provided in the optional venting kit along with the concentric venting adapter (CVA).

If venting vertically through the roof, refer to the vertical concentric venting instructions. If venting horizontally through the wall, refer to the horizontal concentric venting instructions.

NOTE

Vent piping is supplied by others and not supplied by manufacturer.

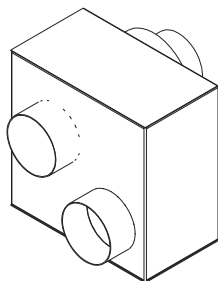

CVA-4
4-inch Concentric Venting Adapter

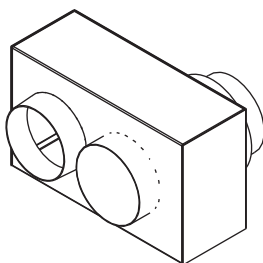

CVA-6
6-inch Concentric Venting Adapter

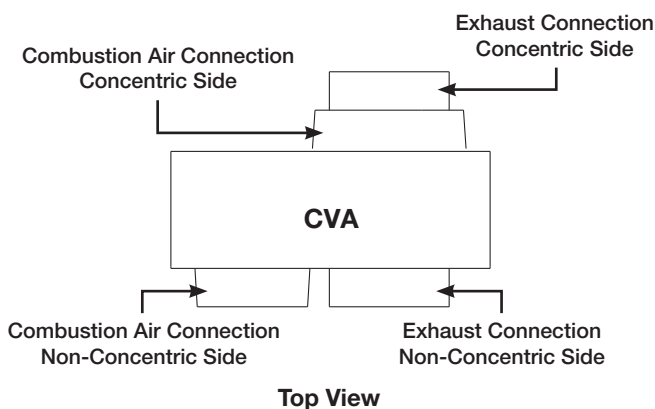

Concentric Venting – Horizontal

Refer to the diagram below for venting on horizontal concentric systems. Maintain at least 12 inches from the combustion air inlet guard to the exhaust vent terminal (Dim. B). To prevent water from running into the combustion air pipe and to allow for easy installation of the combustion air inlet guard, the combustion air pipe must terminate at least 2 inches from the exterior surface of the outside wall (Dim. A).

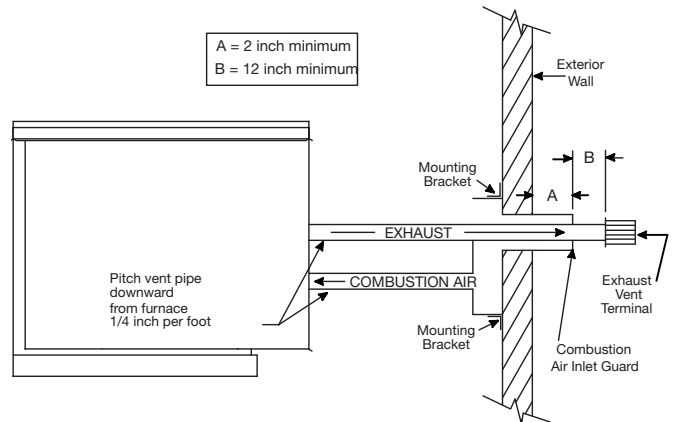

Vent Connection Diameter

Vent terminals must be used (one vent terminal and inlet guard included with each furnace). Construct the vent system as shown in the drawings and refer to the table for the correct vent connection diameters.

Furnace Size (MBH)	Non-Concentric Side Vent Connection Diameter		Concentric Side Vent Connection Diameter	
	Exhaust (inches)	Combustion Air (inches)	Exhaust (inches)	Combustion Air (inches)
75-175	4	4	4	6
200-400	6	6	6	8

Vent Length

Refer to table for minimum and maximum vent lengths. The total equivalent vent length must include elbows. The equivalent length of a 4 inch elbow is 6 feet and the equivalent length of a 6 inch elbow is 10 feet.

Horizontal Concentric Venting		
Vent Length	Minimum (feet)	Maximum (feet)
Horizontal	5	70

Determine Venting Location

Determine the location of the concentric venting adapter (CVA) based on any clearances that must be maintained (follow all codes applicable).

Attach Mounting Brackets

Attach field-supplied, corrosion-resistant, mounting brackets to the CVA using corrosion-resistant sheet metal screws.



Install Exhaust Pipe

Attach a field-supplied exhaust air pipe to the concentric side of the CVA. Provide enough exhaust piping to pass through the wall (or floor) and provide the minimum clearance of 12 inches between the exhaust pipe termination and the combustion air intake. With all required clearances satisfied, attach the exhaust pipe to the CVA.

Install Combustion Air Pipe

Attach a field-supplied combustion air pipe to the concentric side of the CVA.

Be sure to provide enough combustion air piping to pass through the wall and provide the minimum clearance of 2 inches between the combustion air intake and the exterior surface of the outside wall.

Be sure to maintain the minimum clearance of 12 inches between the exhaust pipe termination and the combustion air intake.

Install CVA Assembly

Place the CVA assembly through the wall and verify that all minimum clearance requirements as specified in these instructions are met. Secure the CVA assembly to the wall with corrosion-resistant sheet metal screws through the mounting brackets.

Attach CVA Assembly to Unit

Connect the unit's combustion exhaust to the exhaust connection on the CVA. Connect the unit's combustion air supply intake to the combustion air connection on the CVA.

Install Combustion Air Inlet Guard and Exhaust Vent Terminal

Slide the combustion air inlet guard over the exhaust pipe and fasten it to the combustion air pipe. Attach the exhaust vent terminal to the discharge end of the exhaust piping.

Seal Opening

Seal the opening between the wall and the air intake pipe using an appropriate method.

Concentric Venting – Vertical

Refer to the diagram below for venting on vertical concentric systems. Maintain at least 12 inches between the top of the combustion air inlet terminals and the bottom of the exhaust terminal. (Dim. B).

The bottom of the combustion air intake pipe must terminate above the snow line or at least 12 inches above the roof, whichever is greater.

A tee with a drip leg and a clean-out cap must be provided on the combustion air and exhaust pipe to prevent debris from entering the heat exchanger.

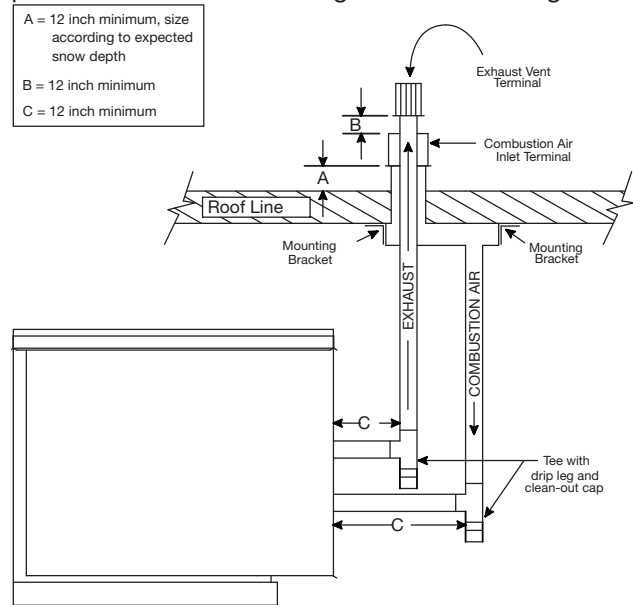

Vent Connection Diameter

Vent terminals must be used (one vent terminal and inlet terminal included with each furnace). Construct the vent system as shown in the drawings and refer to the table for the correct vent connection diameters.

Furnace Size (MBH)	Non-Concentric Side Vent Connection Diameter		Concentric Side Vent Connection Diameter	
	Exhaust (inches)	Combustion Air (inches)	Exhaust (inches)	Combustion Air (inches)
75-175	4	4	4	6
200-400	6	6	6	8

Vent Length

Refer to table. The total equivalent vent length must include elbows. The equivalent length of a 4 inch elbow is 6 feet and the equivalent length of a 6 inch elbow is 10 feet.

Vertical Concentric Venting		
Vent Length	Minimum (feet)	Maximum (feet)
Vertical	10	70

Determine Venting Location

Determine the location of the concentric venting adapter (CVA) based on any clearances that must be maintained (follow all codes referenced in these instructions).

Attach Mounting Brackets

Attach field-supplied corrosion-resistant mounting brackets to the CVA using corrosion resistant sheet metal screws.



Install Exhaust Pipe

Attach a field-supplied exhaust air pipe to the concentric side of the CVA. Provide enough exhaust piping to pass through the roof and provide the minimum clearance of 12 inches between the exhaust pipe termination and the combustion air intake. With all required clearances satisfied, attach the exhaust pipe to the CVA.

Install Combustion Air Pipe

Attach a field-supplied combustion air pipe to the concentric side of the CVA.

Be sure to provide enough combustion air piping to pass through the roof and provide the minimum clearance of 12 inches between the combustion air intake and the exterior surface of the roof. This clearance may need to be increased to allow for snow accumulation.

Be sure to maintain the minimum clearance of 12 inches between the exhaust pipe termination and the combustion air intake.

Install CVA Assembly

Place the CVA assembly through the roof and verify that all minimum clearance requirements as specified in these instructions are met. Secure the CVA assembly to the ceiling with corrosion-resistant sheet metal screws through the mounting brackets.

Attach CVA Assembly to Unit

Connect the unit's combustion exhaust to the exhaust connection on the CVA. Connect the unit's combustion air supply intake to the combustion air connection on the CVA. Be sure to include the required tee's with drip legs and clean-outs.

Install Combustion Air Inlet Guard and Exhaust Vent Terminal

Slide the combustion air terminal over the vent pipe and fasten it to the combustion air pipe. Attach the exhaust vent terminal to the discharge end of the exhaust piping.

Seal Opening

Seal the opening between the roofs and the air intake pipe using an appropriate method.

Installation of Two Pipe Venting – Horizontal

Refer to the diagram for venting on horizontal two pipe systems. Maintain at least 12 inches of clearance between the exhaust pipe termination and the exterior surface of the exterior wall.

The combustion air pipe must be a minimum of 12 inches from the exhaust pipe and 2 inches from the exterior surface of the outside wall.

A maximum of 48 inches of building wall thickness is required for separated combustion vent pipe.

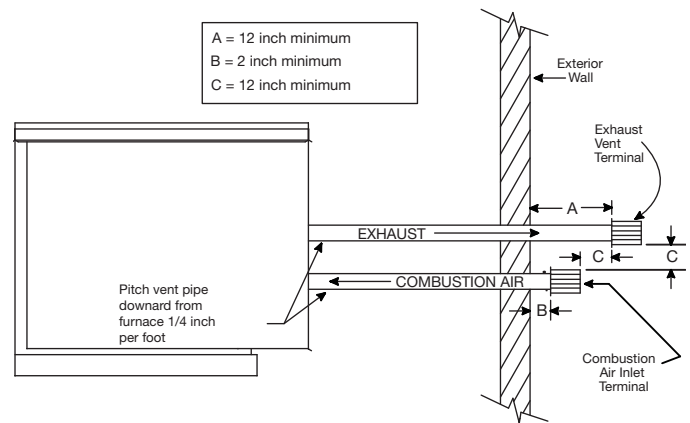

Vent Connection Diameter

Vent terminals must be used. The vent kit includes two terminals per furnace.

Construct the vent system as shown in the drawings and refer to the table for the correct vent connection diameters.

Horizontal Two Pipe Venting Vent Connection Diameter		
Furnace Size (MBH)	Exhaust (inches)	Combustion (inches)
75-175	4	4
200-400	6	6

Vent Length

Refer to table for minimum and maximum vent lengths. The minimum vent length is 5 feet and the maximum vent length is 50 feet.

Horizontal Two Pipe Venting Vent Length		
Vent Length	Minimum (feet)	Maximum (feet)
Horizontal	5	50

The total equivalent vent length must include elbows. The equivalent length of a 4 inch elbow is 6 feet and the equivalent length of a 6 inch elbow is 10 feet.

Install Exhaust Pipe

Run an exhaust pipe from the unit's combustion exhaust through the exterior wall to the outdoors. The exhaust pipe must terminate at least 12 inches from the outside surface of the outside wall. Attach exhaust vent terminal to the end of the exhaust pipe. Using field-supplied mounting brackets, support the exhaust pipe as needed.

Install Combustion Air Pipe

Run a combustion air pipe from the unit's combustion air intake through the exterior wall to the outdoors. The combustion air pipe must terminate at least 12 inches from the exhaust vent pipe and 2 inches from the exterior surface of the outside wall. Attach the combustion air inlet guard to the end of the combustion air pipe. Using field-supplied mounting brackets, support the combustion air pipe as needed.

Seal Wall Openings

Using an appropriate method, seal the wall openings around the piping.



Installation of Two Pipe Venting – Vertical

Refer to the diagram for venting vertical two pipe systems. The combustion air pipe must terminate at least 12 inches above the roof. This clearance may need to be increased to accommodate for snow accumulation. The exhaust must terminate at least 12 inches above and 12 inches horizontally from the combustion air inlet.

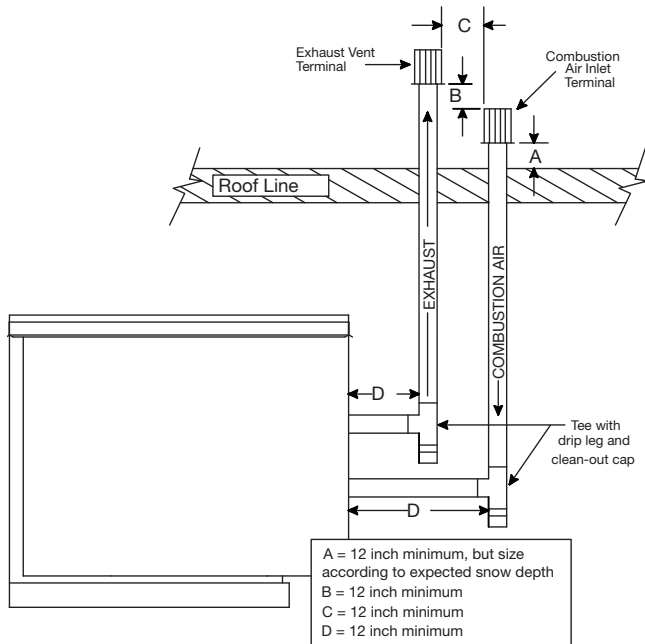

Vent Connection Diameter

Vent terminals must be used. The vent kit includes two terminals per furnace. Construct the vent system as shown in the drawings and refer to the table for the correct vent connection diameters.

Vertical Two Pipe Venting Vent Connection Diameter		
Furnace Size (MBH)	Exhaust (inches)	Combustion (inches)
75-175	4	4
200-400	6	6

Vent Length

Refer to table for minimum and maximum vent lengths. The minimum vent length is 10 feet and the maximum vent length is 70 feet. The total equivalent vent length must include elbows. The equivalent length of a 4 inch elbow is 6 feet and the equivalent length of a 6 inch elbow is 10 feet.

Vertical Two Pipe Venting Vent Length		
Vent Length	Minimum (feet)	Maximum (feet)
Vertical	10	70

Install Exhaust Pipe

Run an exhaust pipe from the unit's combustion exhaust through the roof to the outdoors. The exhaust pipe must terminate at least 24 inches above the outside surface of the roof. This clearance may need to be increased to accommodate snow accumulation. Attach the exhaust vent terminal to the end of the exhaust pipe.

Install Combustion Air Pipe

Run a combustion air pipe from the unit's combustion air intake through the roof to the outdoors. The combustion air pipe must terminate at least 12 inches horizontally and vertically from the combustion exhaust pipe and at least 12 inches from the exterior surface of the roof. These clearances may need to be increased to accommodate for expected snow accumulation. Attach the combustion air terminal to the end of the combustion air pipe.

Seal Roof Penetration

Using an appropriate method, seal the roof openings around the vent pipes.

Installation of Control Wiring

Disconnect power supply before making any wiring connections to prevent electrical shock and equipment damage.

All appliances must be wired strictly in accordance with the wiring diagram furnished with the unit. Any wiring different from the diagram could result in a hazard to persons and property.

Any original factory wiring that requires replacement must be replaced with wiring material having a temperature rating of at least 105° C.

1. Installation of wiring must conform with local building codes. In the absence of local building codes, installation must conform to the National Electrical Code and ANSI/NFPA 70 - Latest Edition. Unit must be electrically grounded in conformance with this code. In Canada, wiring must comply with CSA C22.1, Canadian Electrical Code.
2. All furnaces are provided with a wiring diagram located on the inside of the access panel or door to the unit's furnace. Refer to this diagram for all wiring connections.

Installation of Discharge Air Sensor

Every furnace has a Discharge Air Sensor included. It is typically attached to the terminal strip on the furnace control center. If the ventilating unit has a microprocessor controller, the discharge air sensor will be connected to the microprocessor controller. See the unit-specific wiring diagram. Install sensor in the supply air duct, as far downstream as possible for accurate temperature measurement. Additional wire may be added to the sensor as necessary.



Installation of Gas Piping

IMPORTANT

All gas piping must be installed in accordance with the latest edition of the National Fuel Gas Code ANSI/Z223.1 and any local codes that may apply. In Canada, the equipment shall be installed in accordance with the Installation Code for Gas Burning Appliances and Equipment (CGA B149) and Provincial Regulations for the class. Authorities having jurisdiction should be consulted before installations are made.

IMPORTANT

All piping should be clean and free of any foreign material. Foreign material entering the gas train can cause damage.

WARNING

All components of this or any other gas fired heating unit must be leak-tested prior to placing the unit into operation. A soap and water solution should be used to perform this test. NEVER test for gas leaks with an open flame.

IMPORTANT

Do NOT connect the unit to gas types other than what is specified and do NOT connect the unit to gas pressures that are outside of the pressure range shown on the label.

WARNING

When leak testing pressures equal to or less than 14 in. wg (3.5 kPa), first close the field-installed shutoff valve to isolate the unit from the gas supply line.

WARNING

When leak testing pressures above 14 in. wg (3.5 kPa), close the field-installed shutoff valve, disconnect the furnace and its gas train from the gas supply line and plug the supply line before testing.

NOTE

When connecting the gas supply, the length of the run must be considered in determining the pipe size to avoid excessive pressure drop. Refer to a Gas Engineer's Handbook for gas pipe capacities.

NOTE

Each furnace has a single 3/4-inch connection.

Determine the Gas Supply Requirements

The data label located on the face of the furnace lists the requirements for the gas being supplied to the unit.

Type of Gas		Minimum Gas Supply Pressure	
MODEL NUMBER / NUMÉRO DES MODÈLES: XPVF150H			
TYPE OF GAS / TYPE DE GAZ	NATURAL	TEMPERATURE RISE RANGE / ÉLEVATION DE TEMPÉRATURE	20-100 °F
MAXIMUM EXTERNAL STATIC PRESSURE / PRESSION STATIQUE EST / MAXIMUM	3 IN.W.C. / P.C.C.D.E.	MAXIMUM PRESSURE / PRESSION A LA TIGERIE / CALIBRIMENTATION	3.5 IN.W.C. / P.C.C.D.E.
MINIMUM INPUT BTU/HOUR / PUISSANCE MINIMALE	75,000	MINIMUM GAS SUPPLY PRESSURE / PRESSION MINIMALE D'ALIMENTATION DU GAZ	6 IN.W.C. / P.C.C.D.E.

Typical Furnace Data Label
each unit will be different

Connect the Supply Gas Line

A manual shut off valve, a 1/8 inch plugged test port and a drip leg must be installed between the gas supply pipe and the start of the gas train. The valve and test port must be accessible for the connection of a test gauge. Supply gas connections must be made by a qualified installer and are not furnished by manufacturer.

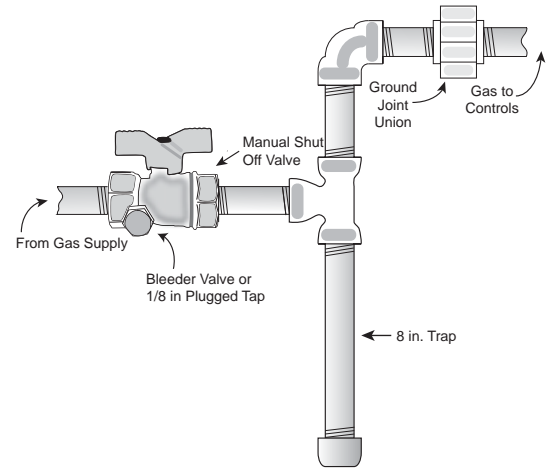

Typical Gas Supply Piping Connection

IMPORTANT

Before applying gas to the valves, test the gas pressure to make sure it is less than 14 in. wg. Pressures greater than 14 in. wg will damage the gas valves.

Install Additional Regulator (if required)

If the gas supply pressure exceeds 14 in. wg, an additional regulator must be installed to reduce the pressure. The additional regulator is to be provided and installed by others. The regulator must have a listed leak limiting device or it must be vented to the outdoors.

Test the System for Leaks

After installing the gas supply piping, perform a leak test in accordance with the instructions in this manual. The leak test must be performed before placing the unit in service.

Gas Pressure Test Ports

Burner manifolds and gas valves used in the furnaces are supplied with test ports for temporary connection of a pressure gauge or a magnehelic gauge.

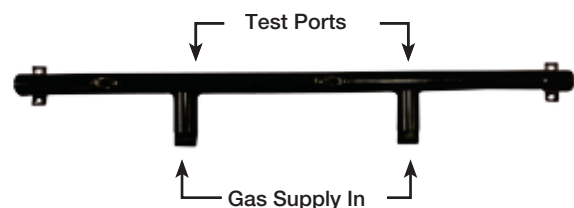

Typical Split Burner Manifold



Sequence of Operation

Start-Up / Standby

Prior to start-up, verify that all field-installed sensors have been installed. This includes a room temperature sensor (optional) and a discharge air temperature sensor (standard).

Heat Mode

When the unit or furnace controller calls for heat:

1. The ignition control will check that the pressure switch for the combustion blower is open.
2. The combustion blower will energize and the 15 second pre-purge begins.
3. The gas valve is energized and the igniter will spark for up to 10 seconds. If a flame is not sensed during the trial for ignition, two additional tries will be attempted before going into lockout for one hour.
4. When a flame is sensed, sparking stops immediately. The gas valve and combustion blower remain energized.
5. Ignition

4:1 Electronic Modulation - The burner will light at 100% fire and remain there for 10 seconds. The main burner gas valve will then modulate from 100% down to a minimum of 25%, as needed. The combustion blower will change between high and low speed to maintain acceptable combustion airflow. If the high speed pressure switch does not pull in when required, the furnace will lock out.

High Turndown Electronic Modulation - The furnace controller will ignite the necessary manifold(s) at 100% for 10 seconds. The main burner gas valves will then modulate from 100%

down to a minimum of 25% as needed. The combustion blower will change between high and low speed to maintain acceptable combustion airflow. If less heat is needed, a manifold section will be turned off. Each time a manifold section is initialized, the manifold section will ignite at 100%.

8:1 Stage Control - The furnace controller will ignite the necessary manifolds at 100% for 10 seconds, after which the unit or furnace controller will operate the manifolds at high and low fire. Each time a manifold is initialized, the manifold will ignite at 100%.

Single Stage Control - The burner will light at 100% and remain at high fire.

Two Stage Control - The burner will light at 100% fire and remain there for 10 seconds. The unit or furnace controller will operate the burners at either high or low fire, depending on the demand for heat.

6. The ignition control constantly monitors the call for heat, the pressure switch and the burner flame to assure proper operation.
7. When the unit or furnace controls are satisfied, the main gas valve is then de-energized and the combustion blower shuts off following a 30 second post-purge period.

Recovery from Lockout

If the furnace goes into lockout, the ignition control will automatically reset after one hour if the thermostat is still calling for heat. If needed, a manual reset can be accomplished by either shutting off the power or turning off the call for heat (turn off the thermostat) for a period of five seconds.

Performance Data

Model	Input (BTU/hr)	Supply Air Temperature Rise								
		20°F	30°F	40°F	50°F	60°F	70°F	80°F	90°F	100°F
		CFM								
50	50,000	1852	1235	926	741	617	529	463	412	370
75	75,000	2778	1852	1389	1111	926	794	694	617	556
100	100,000	3704	2469	1852	1481	1235	1058	926	823	741
125	125,000	4630	3086	2315	1852	1543	1323	1157	1029	926
150	150,000	5556	3704	2778	2222	1852	1587	1389	1235	1111
175	175,000	6481	4321	3241	2593	2160	1852	1620	1440	1296
200	200,000	7407	4938	3704	2963	2469	2116	1852	1646	1481
225	225,000	8333	5556	4167	3333	2778	2381	2083	1852	1667
250	250,000	9259	6173	4630	3704	3086	2646	2315	2058	1852
275	275,000	10185	6790	5093	4074	3395	2910	2546	2263	2037
300	300,000	11111	7407	5556	4444	3704	3175	2778	2469	2222
325	325,000	12037	8025	6019	4815	4012	3439	3009	2675	2407
350	350,000	12963	8642	6481	5185	4321	3704	3241	2881	2593
400	400,000	14815	9877	7407	5926	4938	4233	3704	3292	2963



Start-Up - Furnaces (all units)

IMPORTANT

For the unit to function properly, ALL gas valves must have their high fire and low fire settings adjusted for field conditions.

IMPORTANT

Confirm the discharge air sensor is installed at least three duct diameters downstream of the furnace.

IMPORTANT

Multi-furnace units may use a combination of the available turndown options. Each furnace must be set-up per the specific instructions for its control type. For additional information, see *Gas-Fired Burner Turndown* in this manual.

After the gas piping has been installed and leak tested, verify that all field-installed components such as an air temperature sensor have been installed. Verify that ON/OFF gas control knob on each stage-type gas valve is turned to the "ON" position (see image).

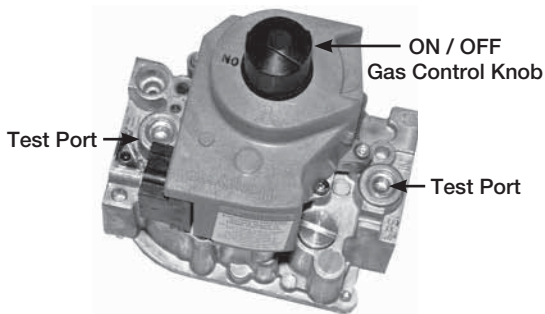

Typical Single Stage Gas Valve

Verify the unit turndown ratio as shown on page 2 of this manual. Consult the specific start-up instructions as shown on the following pages to accomplish the following steps:

Set Airflow

Airflow adjustment is done at the time of unit start-up. Refer to the unit-specific Installation, Operating and Maintenance manual (IOM) for instructions.

With 4:1 Turndown Electronic Modulation

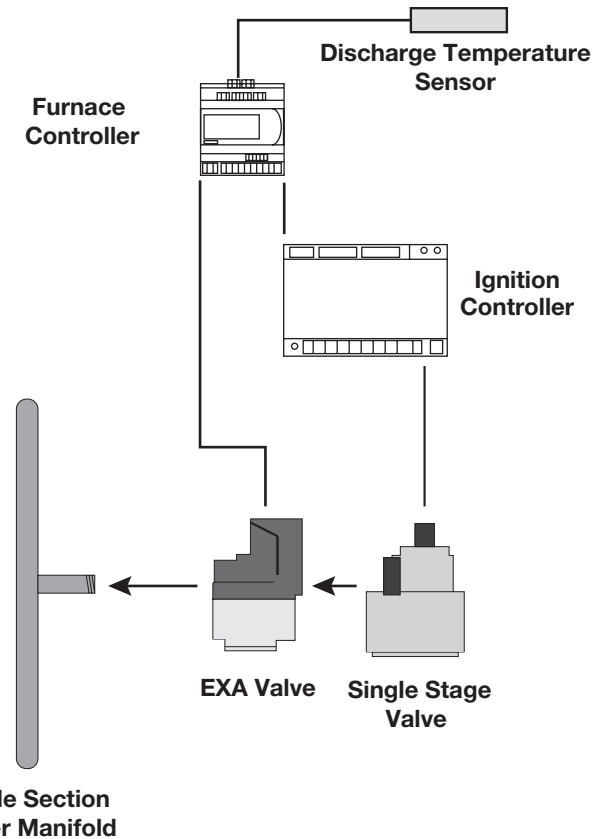

Furnaces with electronically modulated 4:1 turndown use a combination valve for primary gas control. It controls the high fire gas supply and acts as an on/off switching device. The combination valve is normally closed. It requires 24 VAC to hold it open.

The modulating valve is located just after the combination valve. The modulating valve is the device that modulates or changes the gas volume that is being supplied to the furnace manifold. It has a built-in digital controller that will accept user settings for High Fire and Low Fire. During normal use, the amount of combustion gas will vary constantly to regulate the heat output from the furnace. The modulation is controlled by the microprocessor controller through the pCOe expansion board or by the furnace controller. The controller sends a 0-10 VDC analog signal to the modulating valve that causes the valve to send more or less gas to the furnace. The valve also requires a 24 VAC power supply to operate.

When a call for heat is provided to the furnace controller or the pCOe expansion board, the controller will first provide a 10 VDC signal to the modulating valve so that it will always start in a high fire condition. After ignition, the controller will change its output signal, causing the volume of combustion gas to be reduced to as little as 25% of full flow (4:1 turndown) based on demand.

Both of these valves require adjustment at the time of unit start-up.



Before making furnace adjustments, enter the Commissioning Menu on the unit or Furnace Controller. The Commissioning Menu is located under Service > Overrides > Control Loops. Reference the controller IOM for more information about navigating through the controller menus. The Commissioning Menu offers a step by step guide to setting up the furnace. Follow the instructions on the screen. The following sections of this IOM offer detailed information about setting the gas pressures.

Combination Valve Adjustments

Conduct this step when the Commissioning Menu reaches the High Fire Setting screen.

Connect a manometer to the outlet pressure tap on the Honeywell combination valve and remove the cover over the outlet pressure adjustment screw. Use the outlet pressure adjustment screw on the combination valve to adjust the outlet pressure to the value listed in the table.

Combination Valve Outlet Settings	
Natural Gas	5 in. wg
LP Gas	11.5 in. wg

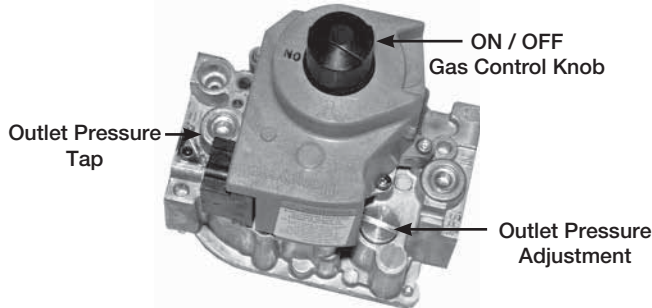

Typical Single Stage Gas Valve

Modulating Valve Adjustments

At start-up, remove the cover from the circuit board housing by loosening the two Phillips head retaining screws. Identify Button #1 and Button #2 and also locate the LED indicator light.

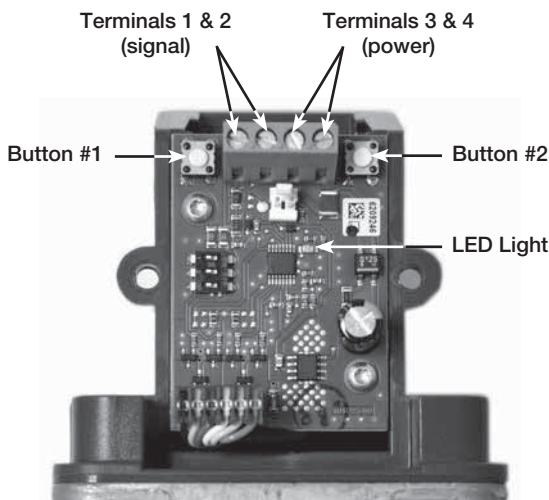

EXA Modulating Gas Valve (with cover removed)

Modulating Valve High Fire Setting

Conduct this step with the Commissioning Menu on the High Fire Setting screen.

1. Connect a manometer to the test port on the burner manifold.
2. Press and hold button #1 until the LED lights solid red. Release the button. Observe the gas pressure on the manometer.
3. Adjust the modulating valve by pushing **button #1 to increase the pressure** or by pushing **button #2 to decrease the pressure**.
4. **Save the High Fire setting by simultaneously holding down buttons #1 and #2 until the LED turns off.** If the new setting is not saved within five minutes, the modulating valve will default back to its last saved setting.

Modulating Valve High Fire Settings	
Natural Gas	3.5 in. wg
LP Gas	10.0 in. wg

NOTE

During the adjustment process, each push of either button will increase or decrease the pressure in steps. Holding down either button auto-steps and eliminates the need to repeatedly push the button. Use this feature to rapidly increase or decrease the gas flow.

Modulating Valve Low Fire Setting

Conduct this step when the Commissioning Menu reaches the Low Fire Setting screen.

1. With a manometer installed at the burner manifold test port, press and hold down button #2 until the LED blinks red. Release the button. Observe the gas pressure on the manometer.
2. Adjust the Low Fire setting by pushing **button #1 to increase the pressure** or by pushing **button #2 to decrease the pressure**.
3. **Save the Low Fire setting by simultaneously holding down buttons #1 and #2 until the LED turns off.** If the new setting is not saved within five minutes, the Modulating Valve will default back to its last saved setting.

Modulating Valve Low Fire Settings	
Natural Gas	0.3 in. wg
LP Gas	1.0 in. wg

Continue through the Commissioning Menu to verify proper furnace operation. If additional furnaces are present, the Commissioning Menu will step through setting up those furnaces as well. Reference the appropriate section in this IOM for detailed information about each furnace.

Reinstall the cover on the modulating valve, remove the manometer and reinstall the plug in the manifold test port.



High Turndown Electronic Modulation

IMPORTANT

*High turndown furnaces use a split burner manifold with a shutoff and a modulating valve on each manifold section. High and low fire manifold pressure must be checked and properly set on each manifold section

**High turndown furnace patent pending.*

Furnaces with electronically modulated high turndown control use two combination valves for primary gas control – one valve controls each manifold section. They control the high fire gas supply and act as on/off switching devices. The combination valves are normally closed and require 24 VAC to hold them open.

A modulating valve is located just after each combination valve. The modulating valve is the device that modulates or changes the gas volume that is being supplied to the furnace manifold. Its function is described in the 4:1 Turndown Electronic Modulation section.

When a manifold section is initiated, the furnace controller will first provide a 10 VDC signal to the modulating valve so that it will always start in a high fire condition. After ignition, the controller will change its output signal, causing the volume of gas to be reduced to as little as 25% of full flow (4:1 turndown) based on demand.

If less heat is needed, a manifold section is turned off and the remaining manifold section is allowed to modulate based on demand.

Adjustment of the high turndown modulation system follows the same steps as the 4:1 modulation system. The same settings must be performed on each manifold section. Refer to the 4:1 modulation section for proper adjustment of each section of the high turndown modulating furnace.



With 8 Stage Control

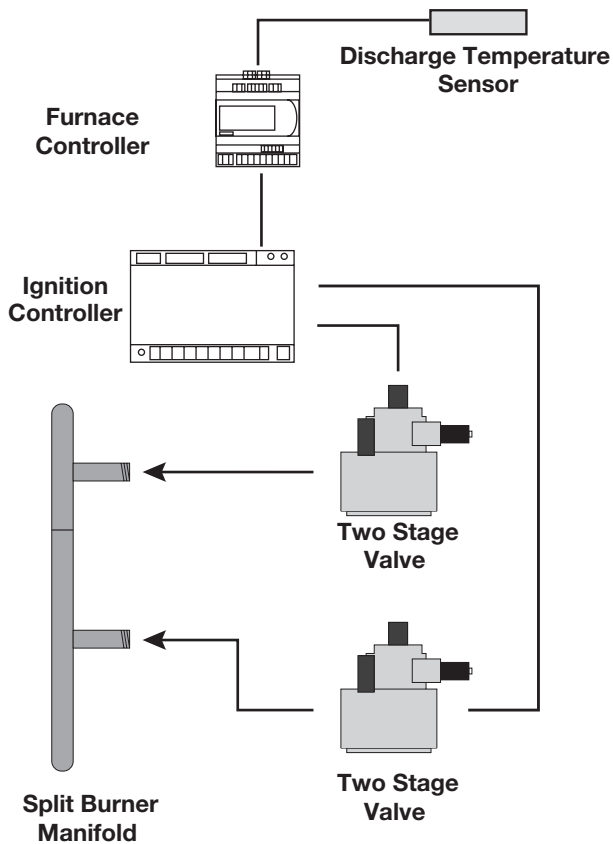

IMPORTANT

8 staged turndown furnaces use a split burner manifold and two 2-stage gas valves per furnace. The high fire and low fire manifold pressure must be checked and properly set on each manifold.

1. Connect a manometer to each test port on the burner manifold.
2. Enter the Commissioning Menu on the unit or furnace controller. The Commissioning Menu is located under Service > Overrides > Control Loops. Reference the controller IOM for more information about navigating through the controller menus. The Commissioning Menu offers a step by step guide to setting up the furnace. Follow the instructions on the screen.
3. When the Commissioning Menu reaches the High Fire Setting Screen, check the gas pressure at the manifold test port.
4. Adjust the high fire screw on the combination valve that is connected to the port being tested. Counterclockwise rotation will decrease the gas pressure and clockwise rotation will increase the pressure.

8 Stage High Fire Settings	
Natural Gas	3.5 in. wg
LP Gas	10.0 in. wg

5. When the Commissioning Menu reaches the Low Fire Setting screen, check the gas pressure at the manifold test ports.
6. Continue through the Commissioning Menu to verify proper furnace operation.
7. When commissioning is complete, turn off furnace. Remove manometer and reinstall plug into manifold test port.
8. If only one manometer was available, connect it to the other manifold test port and re-enter the Commissioning Menu. Repeat this procedure for the other manifold section.
9. Verify that all pressure test ports are plugged and return unit to normal operation.

8 Stage Low Fire Settings	
Natural Gas	7/8 in. wg
LP Gas	2.5 in. wg

With Single Stage Control

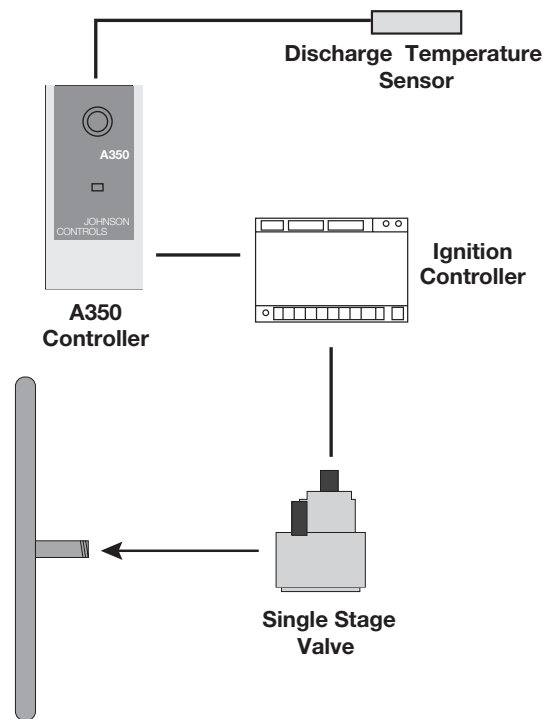

Single Section Burner Manifold

1. Connect a manometer to the test port on the burner manifold.
2. Send the unit to high fire.
3. Check the gas pressure at the manifold test port.
4. Adjust the high fire screw on the combination valve. Counterclockwise rotation will decrease the gas pressure and clockwise rotation will increase the pressure.
5. Turn off furnace. Remove manometer and reinstall plug into manifold test port.
6. Return the unit to normal operation.

Single Stage High Fire Settings	
Natural Gas	3.5 in. wg
LP Gas	10.0 in. wg



With 2 Stage Control

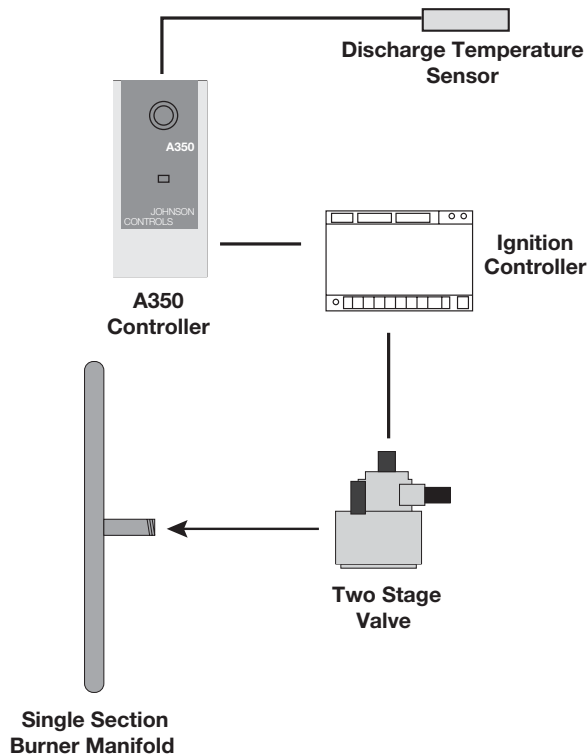

IMPORTANT

Confirm that the discharge air sensor is installed in the duct at least three duct diameters downstream of the furnace.

1. Connect a manometer to the test port on the burner manifold.
2. Send the unit to high fire.
3. Check the gas pressure at the manifold test port.
4. Adjust the high fire screw on the valve. Counterclockwise rotation will decrease the gas pressure and clockwise rotation will increase the pressure.
5. Send the furnace to low fire by disconnecting and isolating the wire from the high fire terminal on the valve.
6. Check the gas pressure at the manifold test port.
7. Adjust the low fire screw on the valve. Counterclockwise rotation will decrease the gas pressure and clockwise rotation will increase the gas pressure.
8. Turn off furnace. Reconnect the wire to the high fire terminal. Remove manometer and reinstall plug into manifold test port.
9. Return the unit to normal operation.

2 Stage High Fire Settings	
Natural Gas	3.5 in. wg
LP Gas	10.0 in. wg

2 Stage Low Fire Settings	
Natural Gas	7/8 in. wg
LP Gas	2.5 in. wg

With Combination Turndown Configurations

There are several different turndown options that may be used in the units that are simply combinations of basic configurations.

In all cases, all gas valves must be set for high fire and low fire as part of the Start-Up process.

Inspect the furnace(s) and verify the type of valve(s) and manifold used. Refer back to the previously described configurations and find the one that most closely matches the valve and manifold types present in this unit. Adjust the high fire and low fire settings on all valves before placing the unit in service.

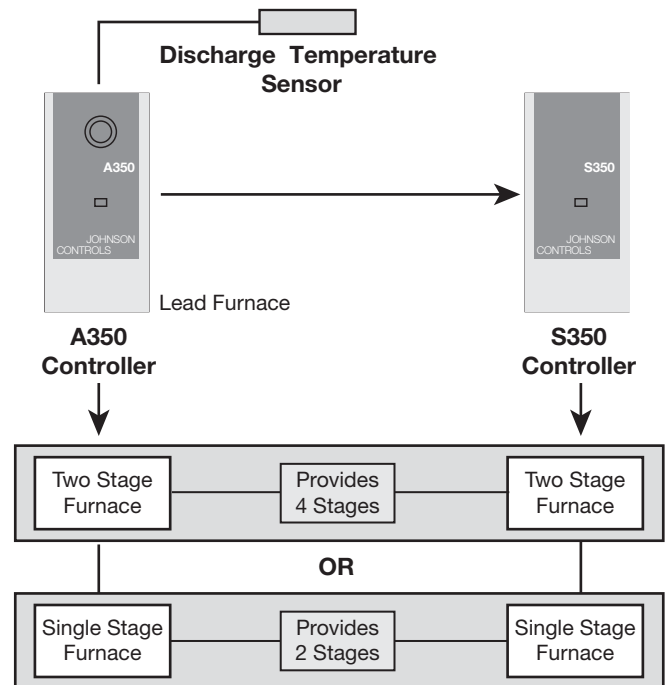

A modulating furnace can also be combined with a single stage furnace. Both furnaces are then controlled by a furnace controller.

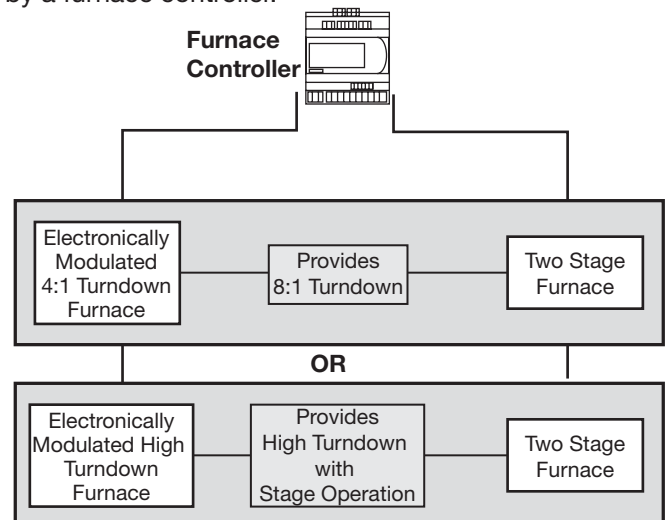

In some cases, two furnaces may be installed in parallel in one ventilating unit. In that case, the turndown is the same as just a single furnace.



Troubleshooting - Ignition Controller

NOTE

The green LED light indicates NORMAL operation while the red LED light indicates an ERROR operation.

The ignition controller has a diagnostic LED light at the top right of the controller. The LED light will flash GREEN for normal operation or RED for an error.

The following are the green LED codes of operation:

GREEN LED Indications - NORMAL OPERATION	
Flash Code	Flash Code Indication
Steady on	Flame detected, main burner on
0.1 second on/off	Controller is generating spark
0.5 second on/off	Purge or inter-purge time
0.5 second on/4.5 second off	Retry or recycle time

The following are the red LED codes of error:

RED LED Indications - ERROR OPERATION	
Flash Code	Flash Code Indication
Blinks 1 time	No flame in trial time error
Blinks 2 times	Flame sense circuit error
Blinks 3 times	Valve circuit error
Blinks 4 times	Flame loss error
Blinks 6 times	Airflow error
Blinks 7 times	Ground or internal error
Steady on	Line voltage/frequency error

Airflow Fault (6 red flashes)

An airflow fault may occur for the following reasons:

- During the start-up sequence, the controller relay turned the combustion blower on, but the blower did not prove airflow in 30 seconds.
- During the start-up sequence, the airflow was proven before the controller turned the combustion blower on. If this condition lasts for 30 seconds, the control will error out.

To fix fault, determine which error above is occurring, remove power from controller, fix problem and re-power controller.

Flame Fault (2 red flashes)

If the main gas valve fails to close completely and maintains a flame, the full-time flame sensor circuit will detect it and energize the combustion blower. Should the main valve later close completely and remove the flame signal, the combustion will be de-energized.

Ignition lockout (1 red flash for start-up, 4 red flashes for during operation)

Possible Cause	Solution
Manual gas valve not open	Open manual valve. If combination valves are used, verify that switch on top is in "ON" position.
Air in the gas line	Bleed gas line.
Supply gas pressure too high or too low	Check that supply pressure is between 6 and 14 in. wg for natural gas and between 11 and 14 in. wg for LP gas.
Loose wire connections	Check for tight wire connections.
No Spark: a. Spark electrode	Ensure spark gap is 1/8 inch and ceramic insulator is not cracked. Replace if necessary.
b. Spark cable shorted to ground	Replace spark cable.
c. Ignition controller not grounded	Ground ignition controller.
High Limit Control tripped	Check unit airflow and manifold pressure.
Faulty combination valve	Measure voltage between terminals MV and Common. If 24 volts is present but valve remains closed, replace valve.
Faulty ignition control	Check diagnostic LED on controller for "steady on". If LED remains on constantly and there is NO voltage between valve and ground, replace ignition controller.

Valve Circuit Error (3 red flashes)

Check that the valve is a 24 volt AC valve. Check that the valve is wired correctly.

Internal Control Error (7 red flashes)

Check all ground connections including the entire unit.

Line Frequency/Voltage Error (solid red)

Check that the controller power is 24 volt AC (+10%/-15%). Check for 60 Hz or 50 Hz.

If all checks have been made using the troubleshooting guide and you have confirmed there are no other defective components, and the red LED error light is flashing or on, then the ignition controller may need to be replaced.



Troubleshooting - 4:1 Modulating Furnace

4:1 Modulating Furnace with Stand-Alone Controller Will Not Light

In all cases, verify correct terminals as shown on the unit-specific wiring diagram.

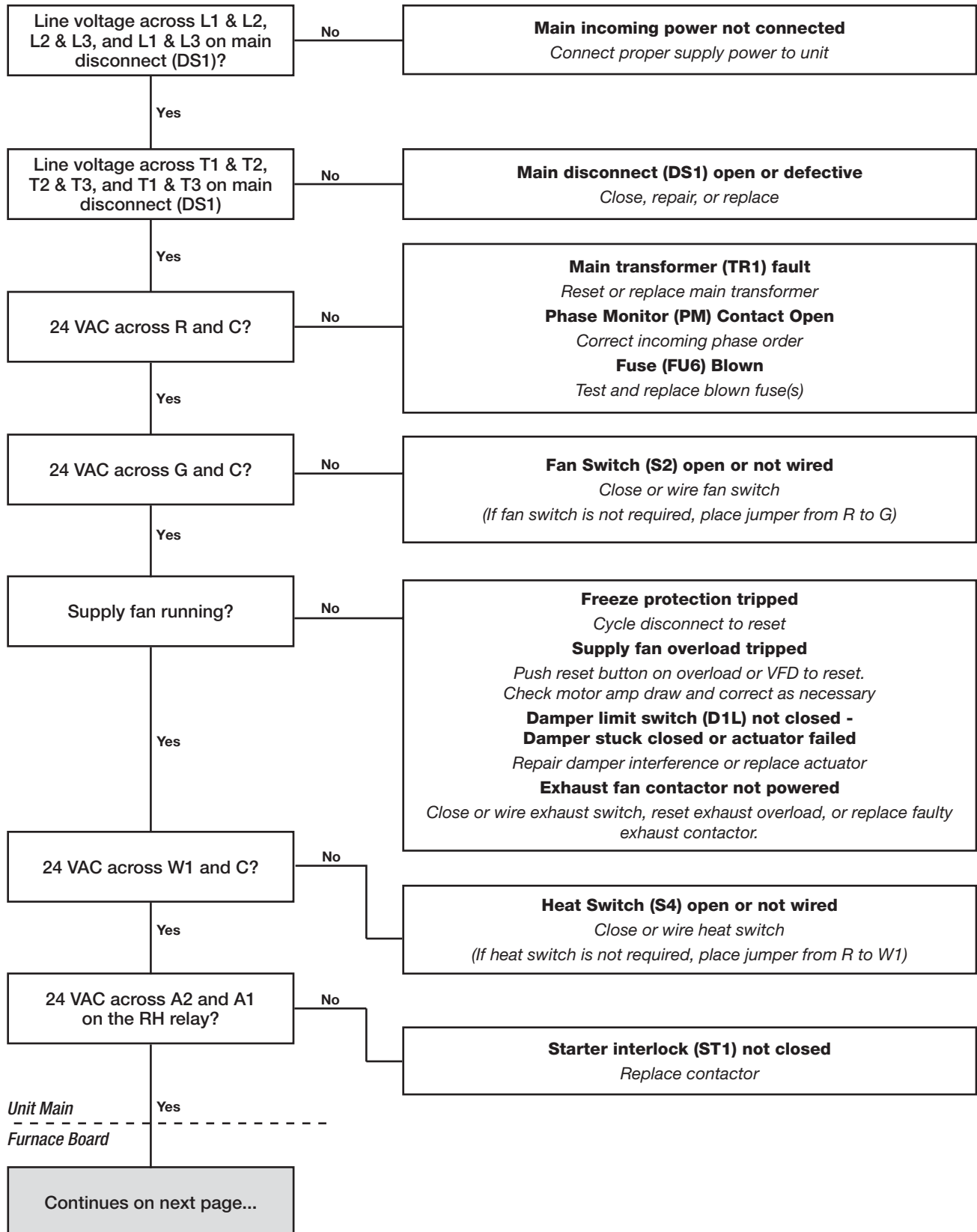

Troubleshooting - 4:1 Modulating Furnace

4:1 Modulating Furnace with Stand-Alone Controller Will Not Light

In all cases, verify correct terminals as shown on the unit-specific wiring diagram.

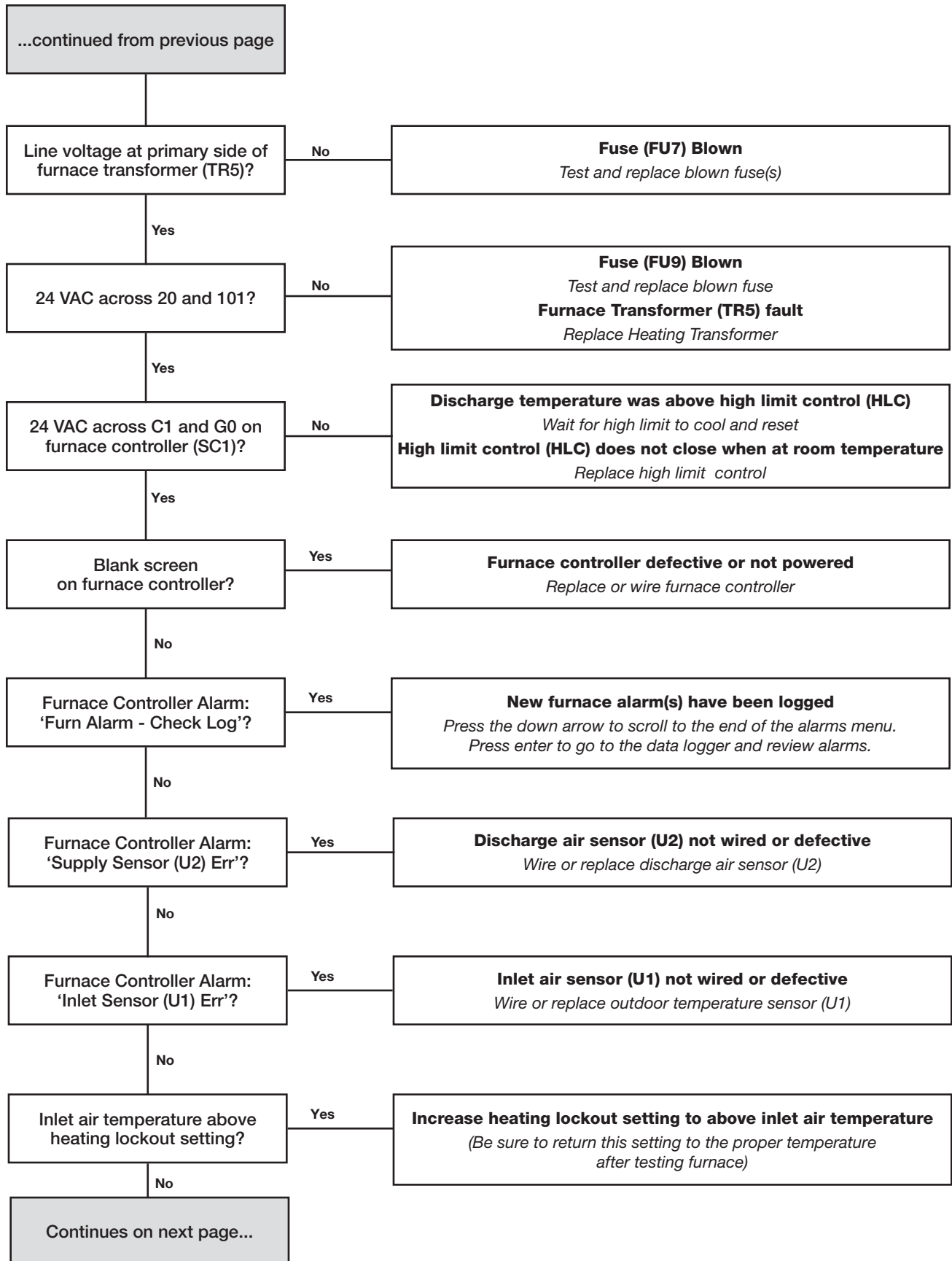

Troubleshooting - 4:1 Modulating Furnace

4:1 Modulating Furnace with Stand-Alone Controller Will Not Light

In all cases, verify correct terminals as shown on the unit-specific wiring diagram.

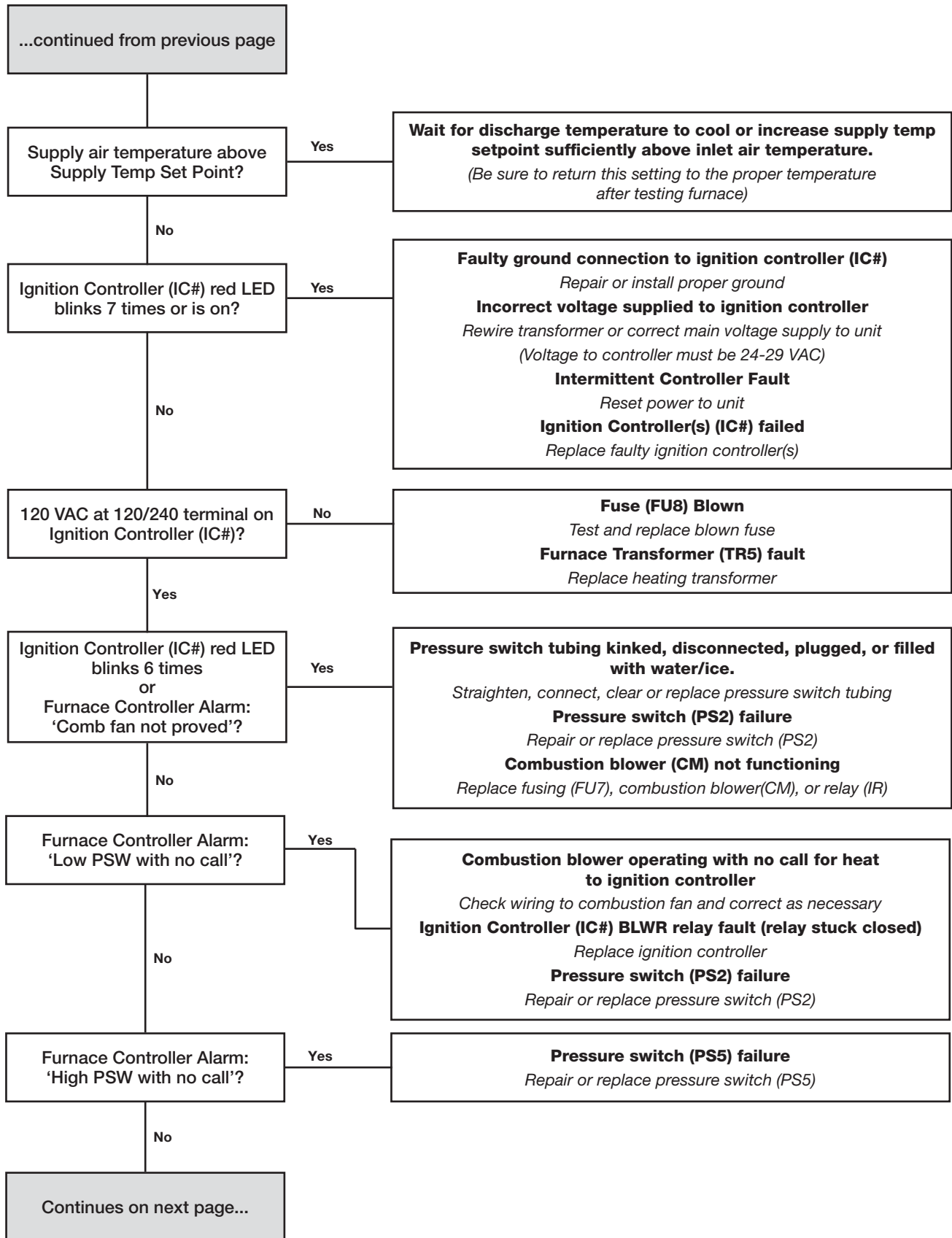

Troubleshooting - 4:1 Modulating Furnace

4:1 Modulating Furnace with Stand-Alone Controller Will Not Light

In all cases, verify correct terminals as shown on the unit-specific wiring diagram.

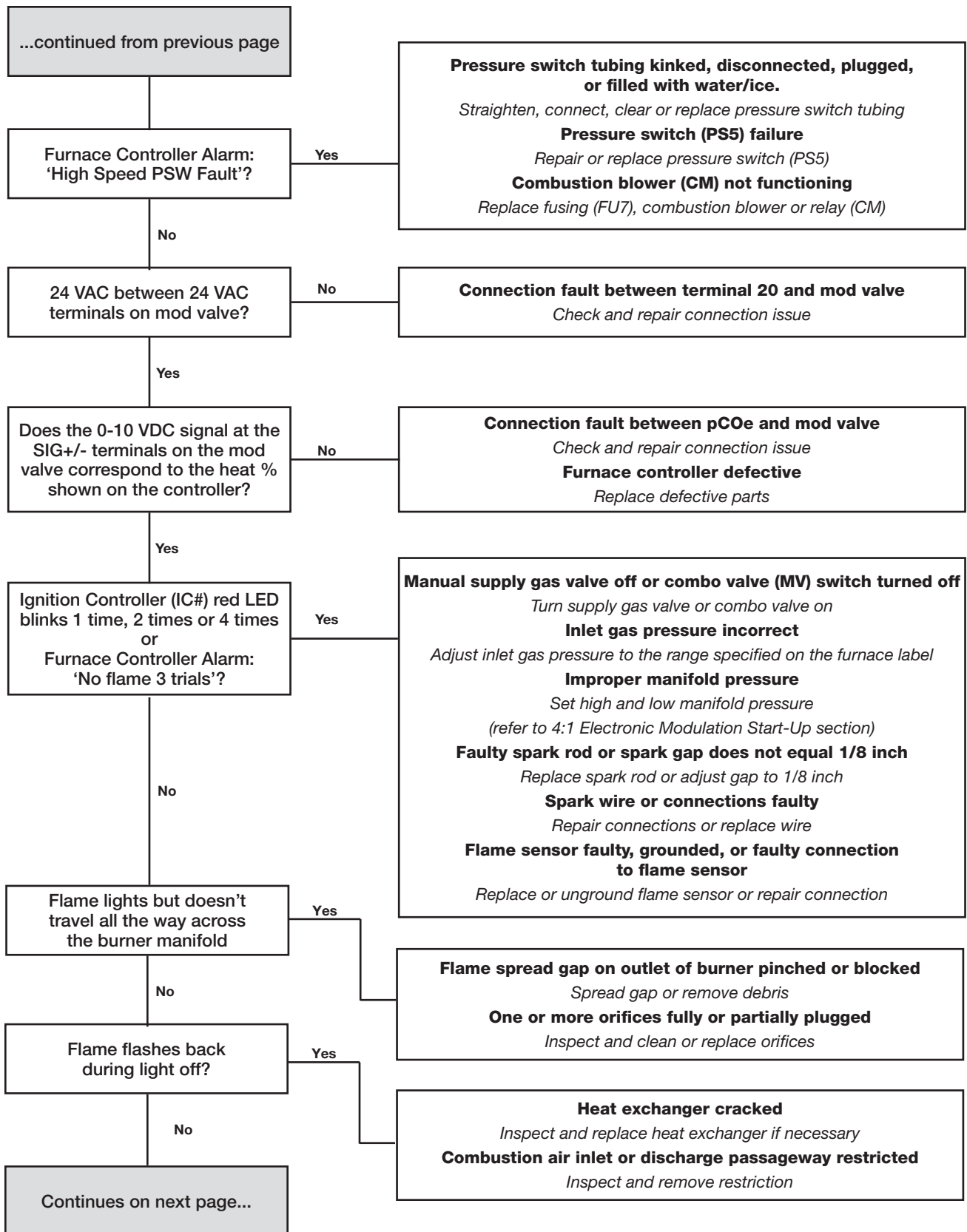

Troubleshooting - 4:1 Modulating Furnace

4:1 Modulating Furnace with Stand-Alone Controller Will Not Light

In all cases, verify correct terminals as shown on the unit-specific wiring diagram.

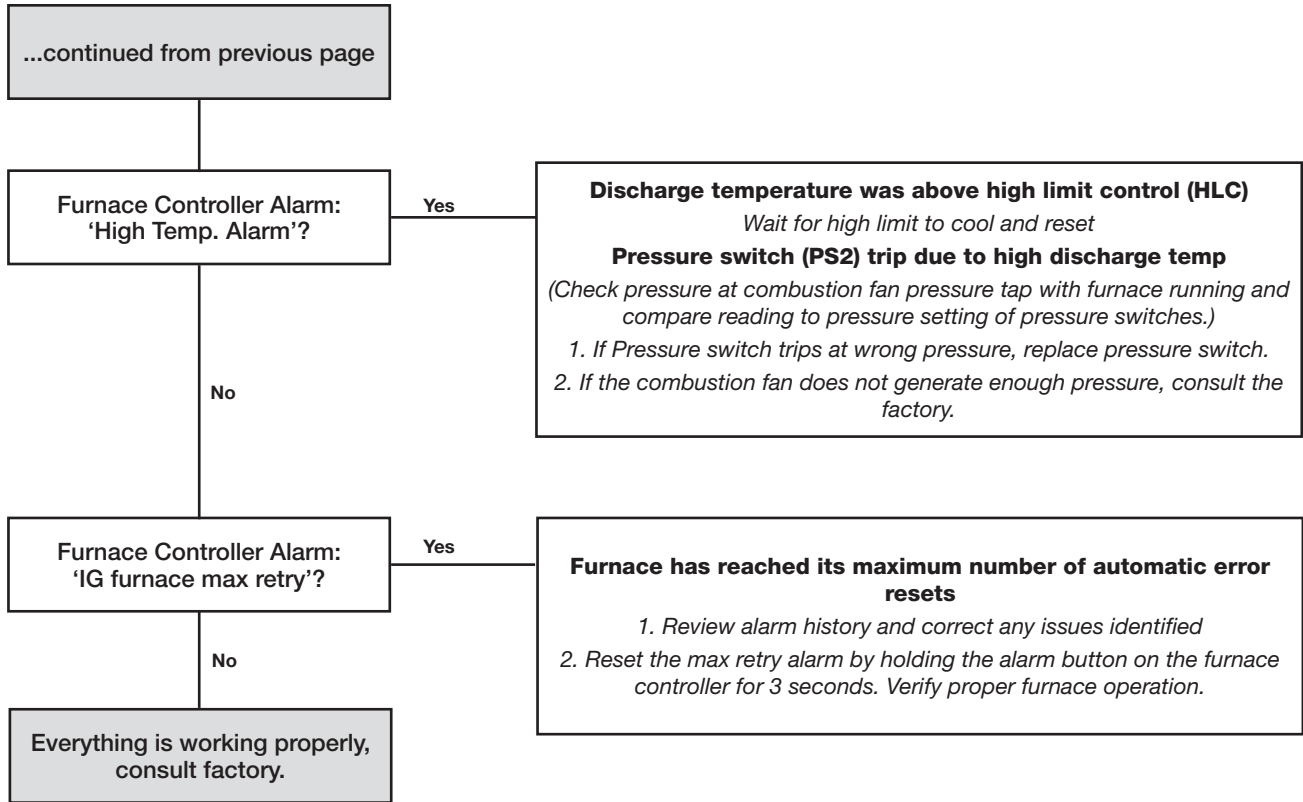

Troubleshooting - 4:1 or High Turndown Modulating Furnace

4:1 or High Turndown Modulating Furnace with Microprocessor Controller Will Not Light

In all cases, verify correct terminals as shown on the unit-specific wiring diagram.

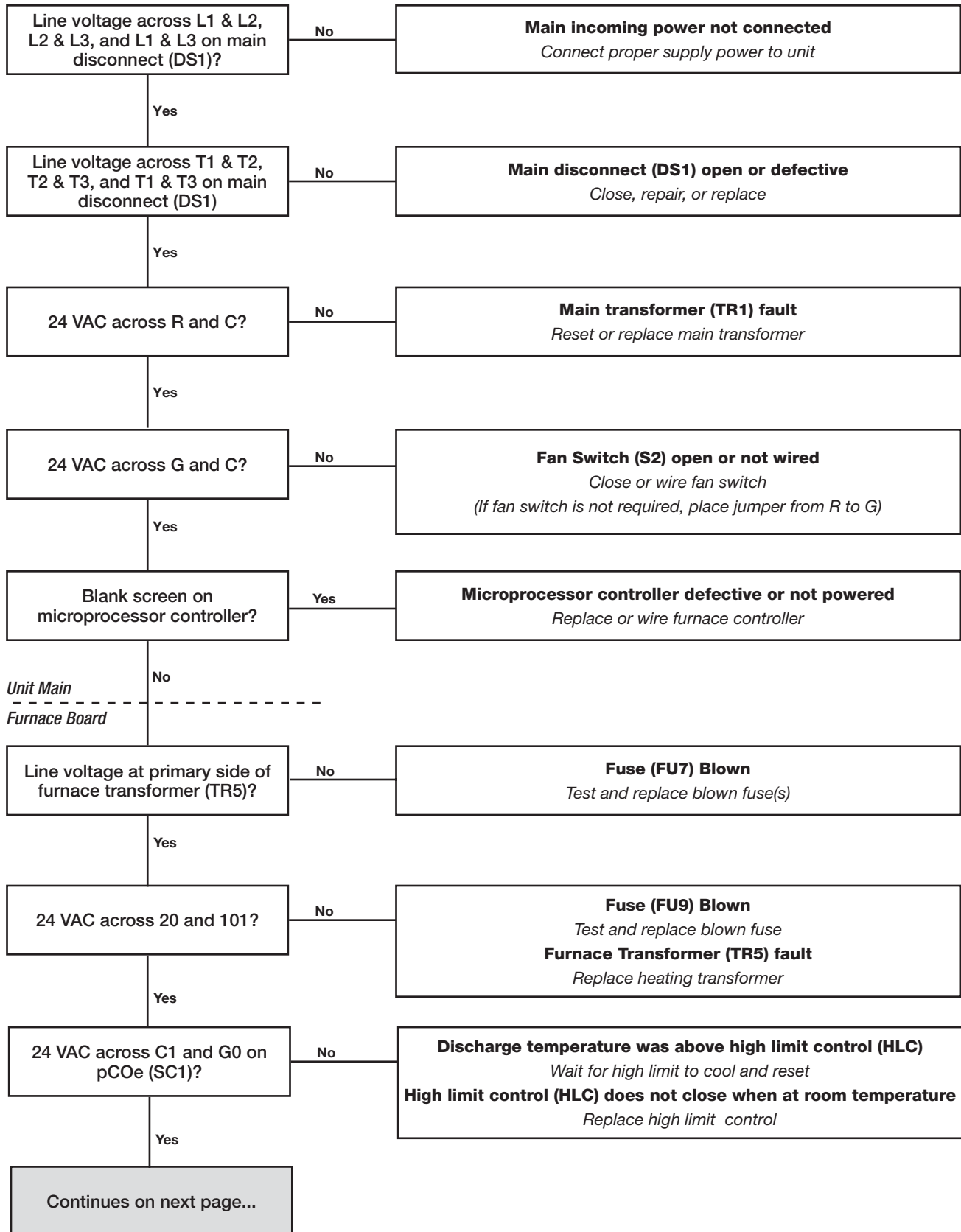

Troubleshooting - 4:1 or High Turndown Modulating Furnace

4:1 or High Turndown Modulating Furnace with Microprocessor Controller Will Not Light
In all cases, verify correct terminals as shown on the unit-specific wiring diagram.

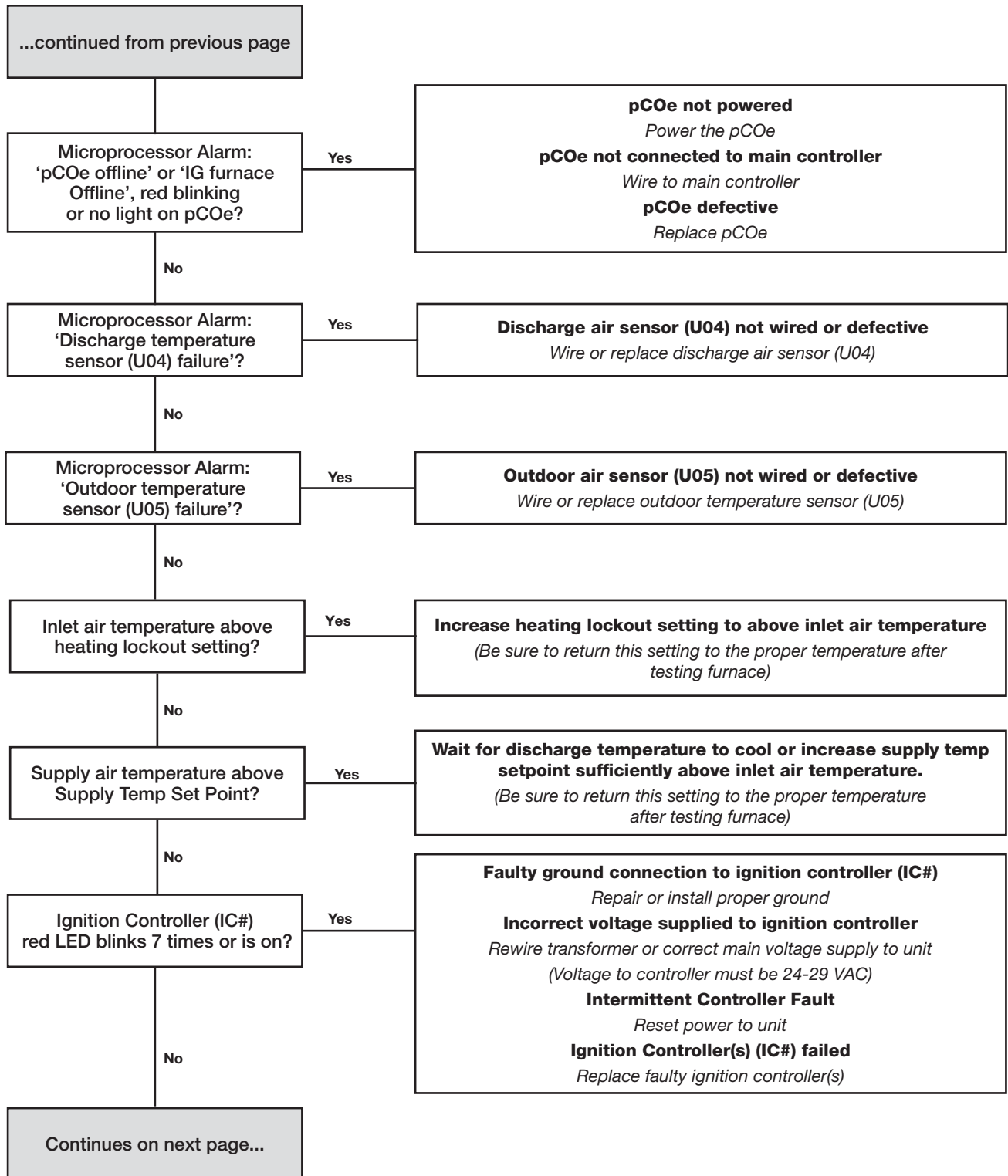

Troubleshooting - 4:1 or High Turndown Modulating Furnace

4:1 or High Turndown Modulating Furnace with Microprocessor Controller Will Not Light

In all cases, verify correct terminals as shown on the unit-specific wiring diagram.

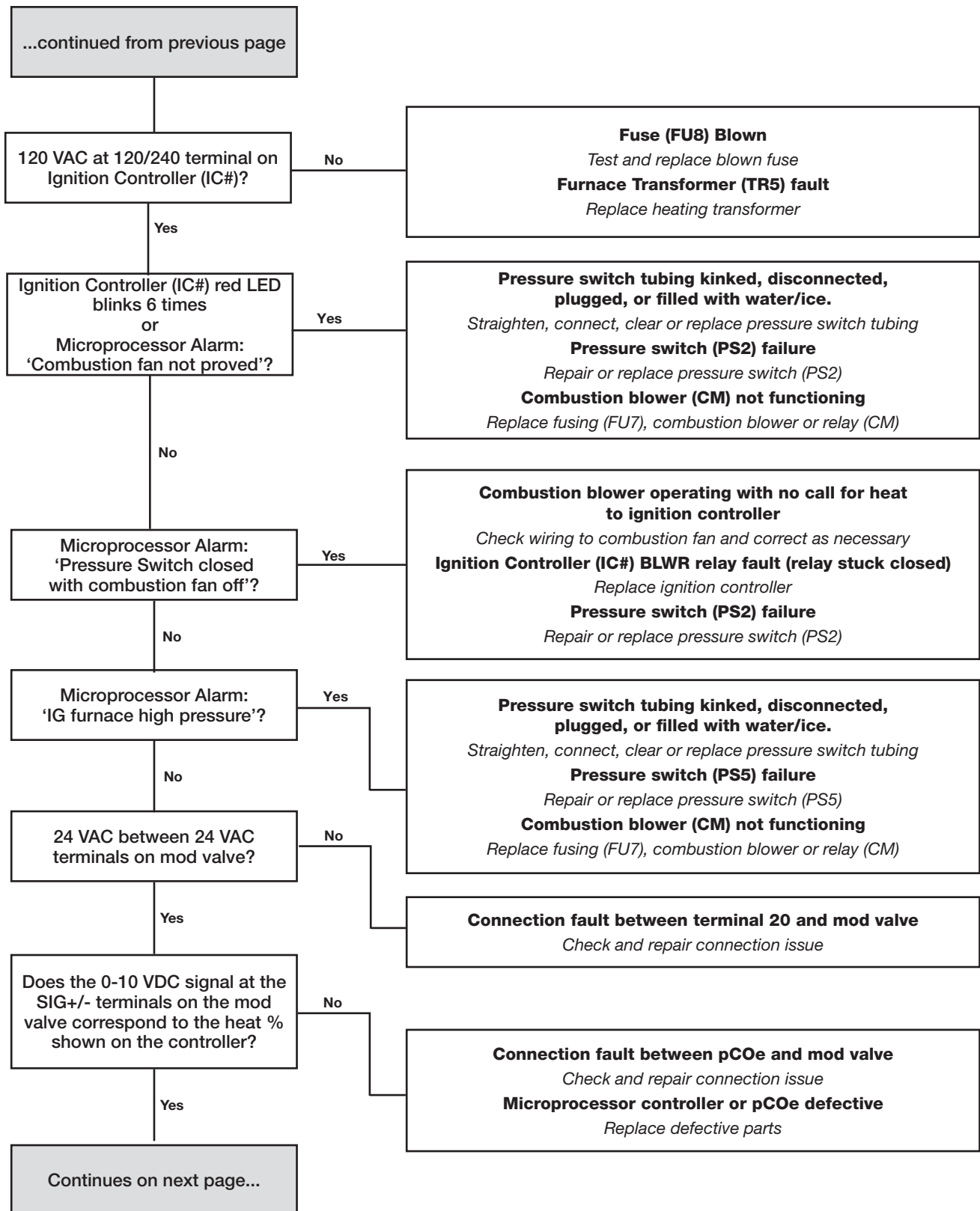

Troubleshooting - 4:1 or High Turndown Modulating Furnace

4:1 or High Turndown Modulating Furnace with Microprocessor Controller Will Not Light
In all cases, verify correct terminals as shown on the unit-specific wiring diagram.

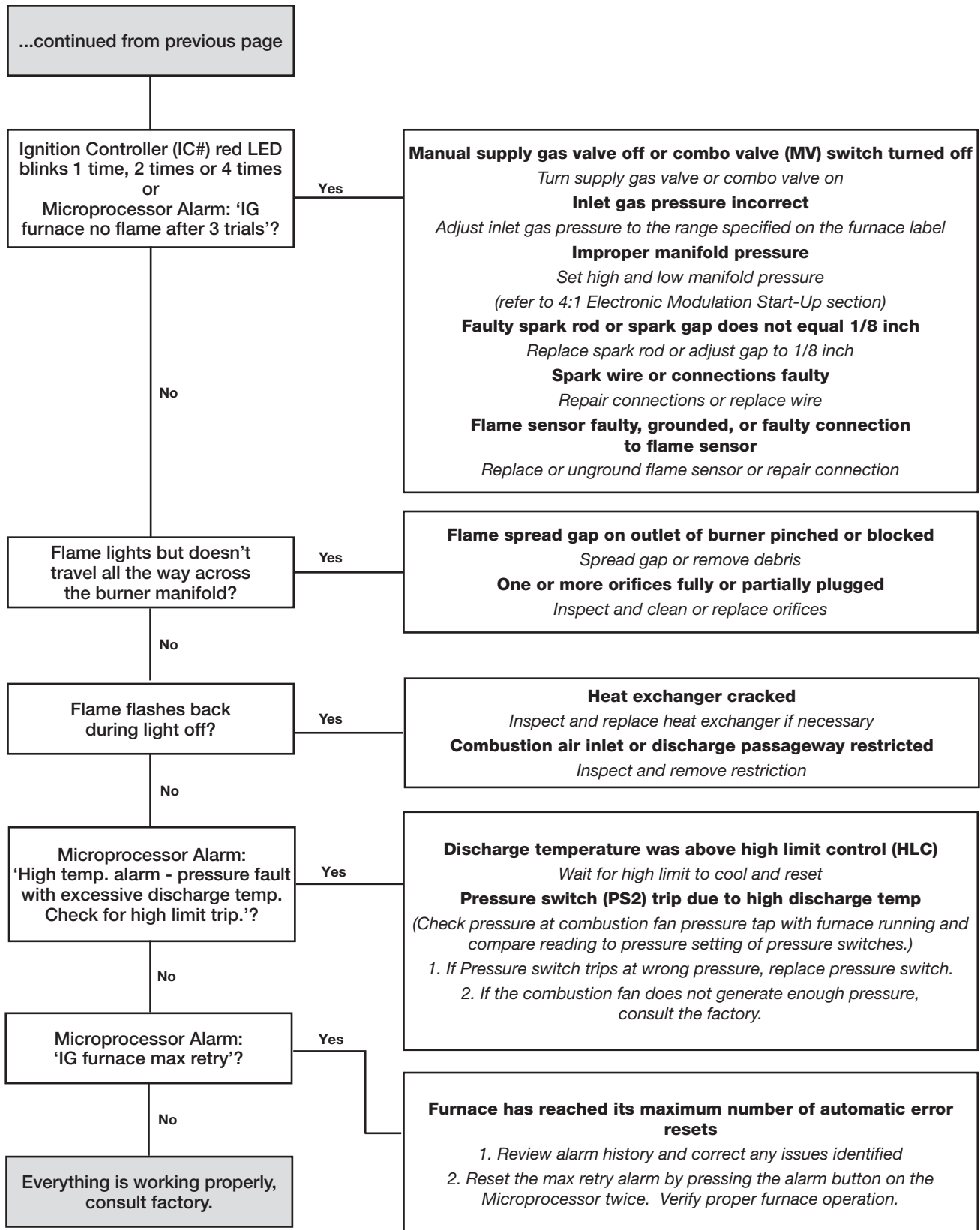

Troubleshooting - 8 Stage Furnace

8 Stage Furnace with Stand-Alone Controller Will Not Light

In all cases, verify correct terminals as shown on the unit-specific wiring diagram.

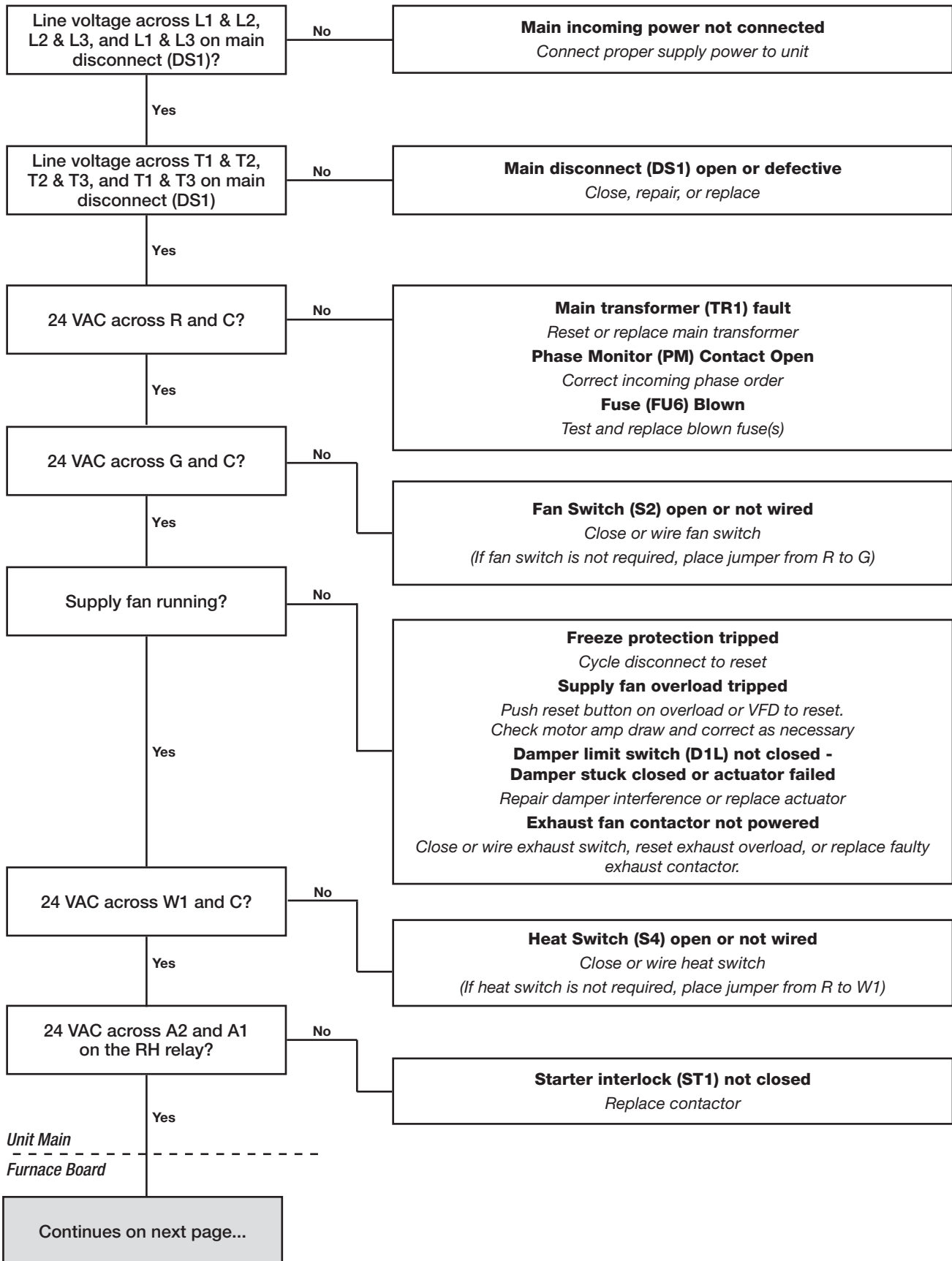

Troubleshooting - 8 Stage Furnace

8 Stage Furnace with Stand-Alone Controller Will Not Light

In all cases, verify correct terminals as shown on the unit-specific wiring diagram.

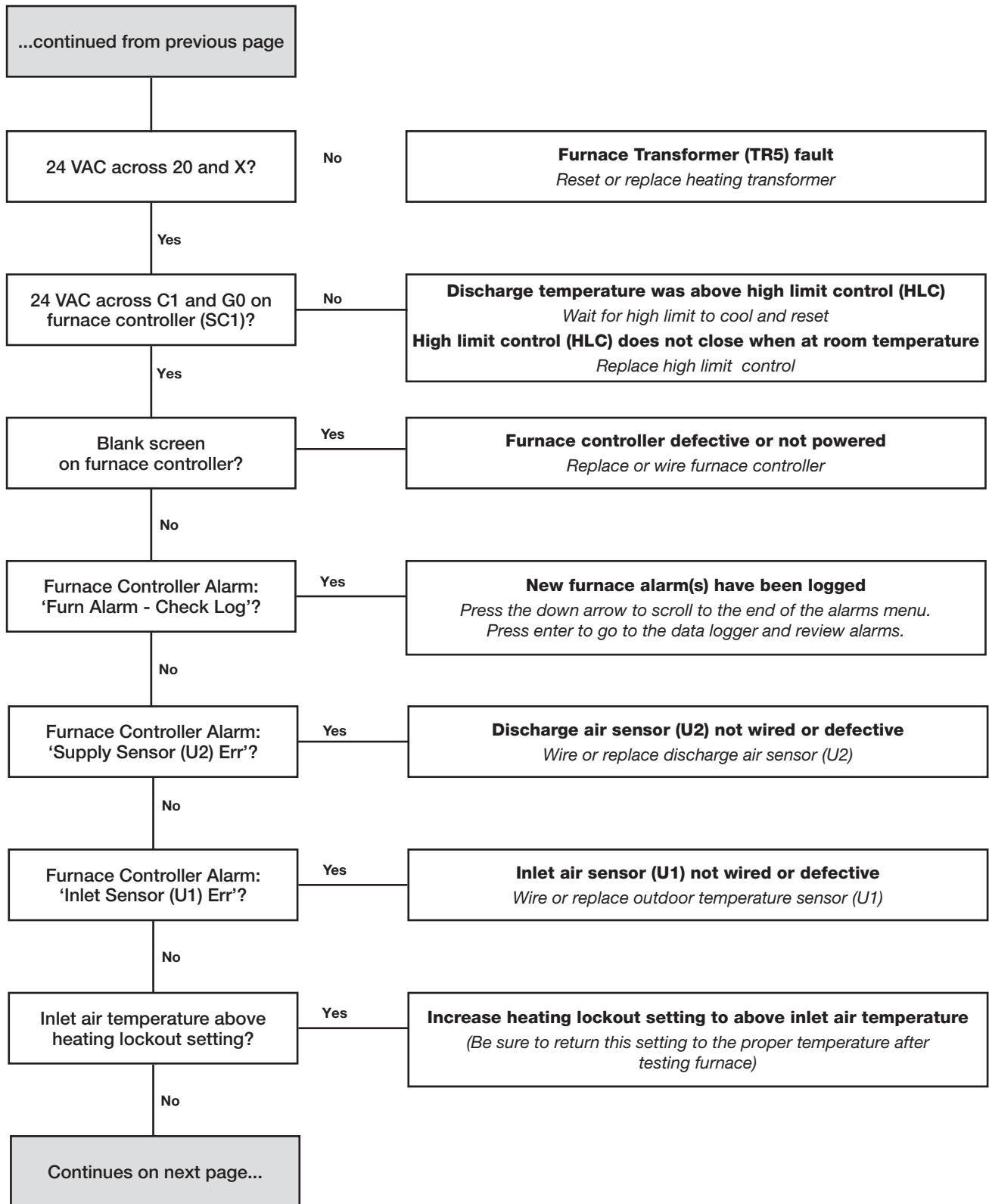

Troubleshooting - 8 Stage Furnace

8 Stage Furnace with Stand-Alone Controller Will Not Light

In all cases, verify correct terminals as shown on the unit-specific wiring diagram.

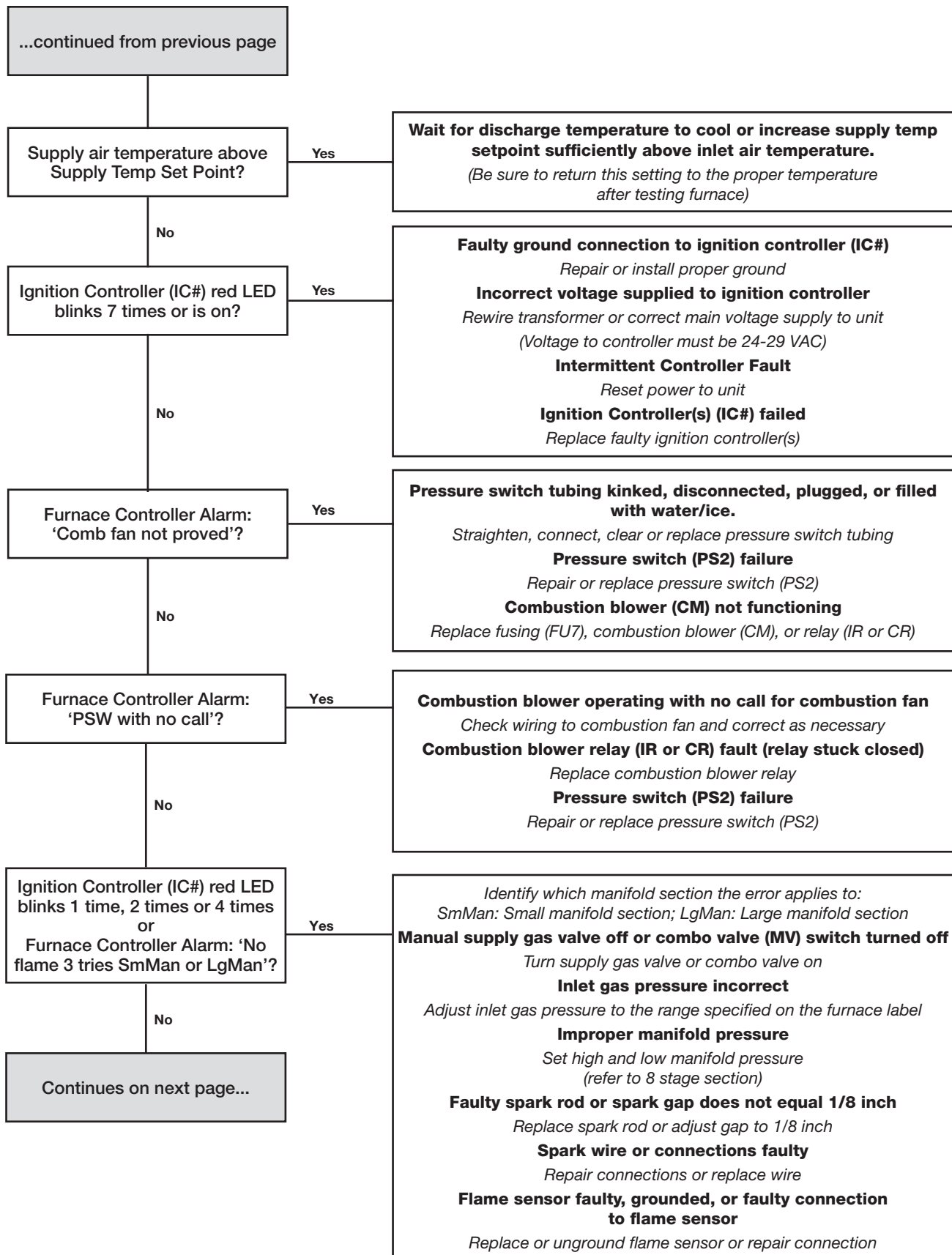

Troubleshooting - 8 Stage Furnace

8 Stage Furnace with Stand-Alone Controller Will Not Light

In all cases, verify correct terminals as shown on the unit-specific wiring diagram.

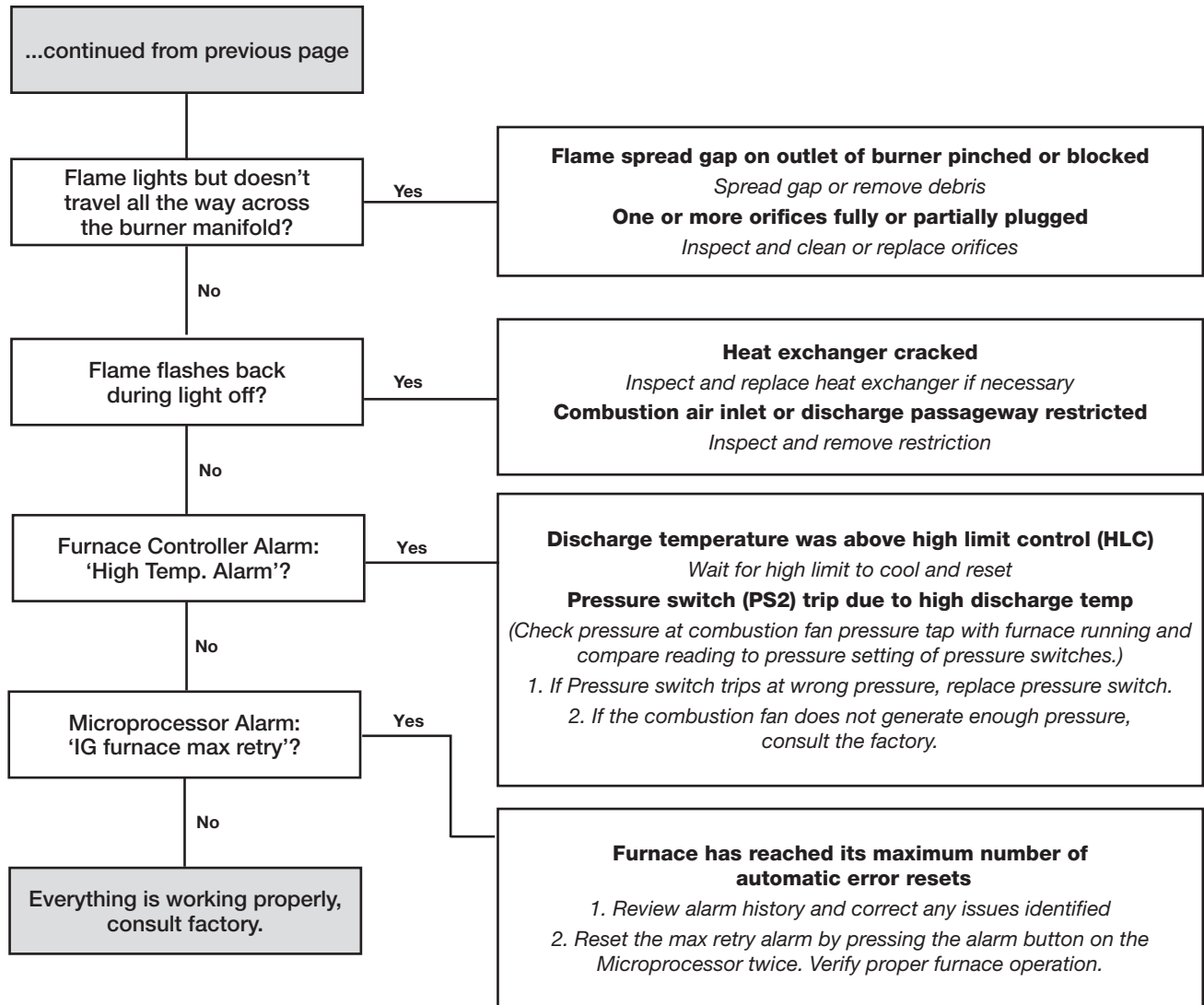

Troubleshooting - Single or Two Stage Furnace

Single or Two Stage Furnace with Stand-Alone Controller Will Not Light

In all cases, verify correct terminals as shown on the unit-specific wiring diagram.

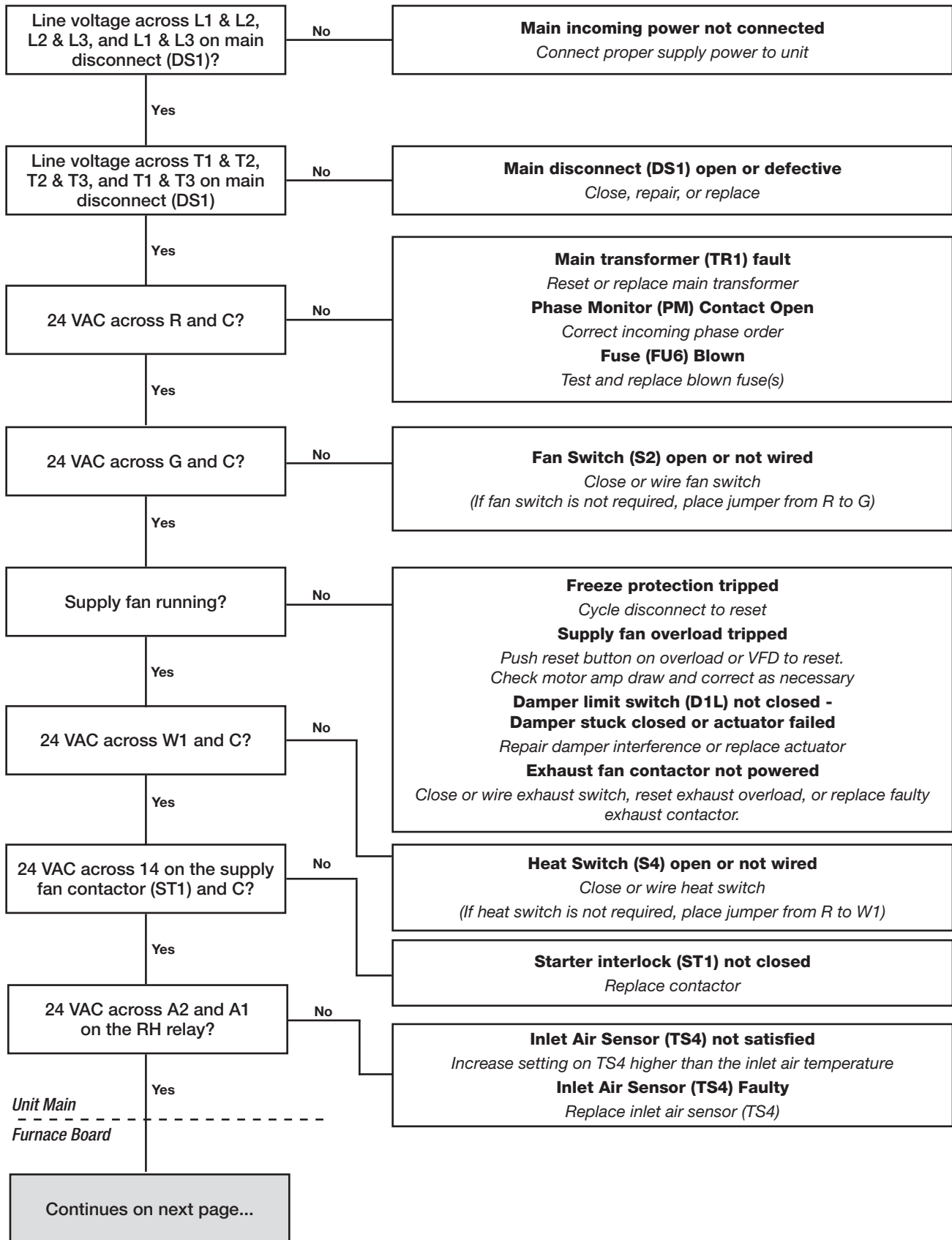

Troubleshooting - Single or Two Stage Furnace

Single or Two Stage Furnace with Stand-Alone Controller Will Not Light

In all cases, verify correct terminals as shown on the unit-specific wiring diagram.

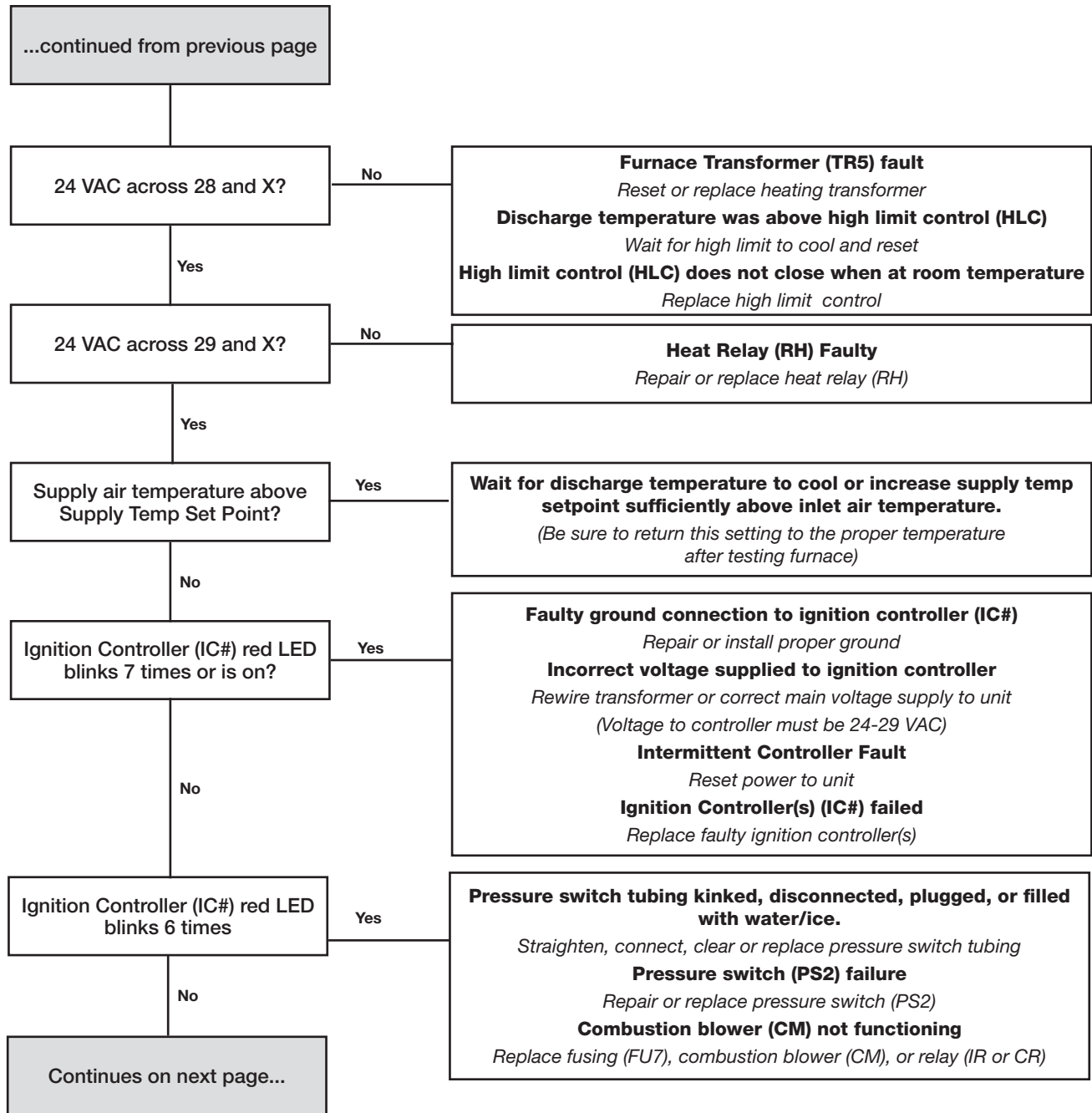

Troubleshooting - Single or Two Stage Furnace

Single or Two Stage Furnace with Microprocessor Controller Will Not Light

In all cases, verify correct terminals as shown on the unit-specific wiring diagram.

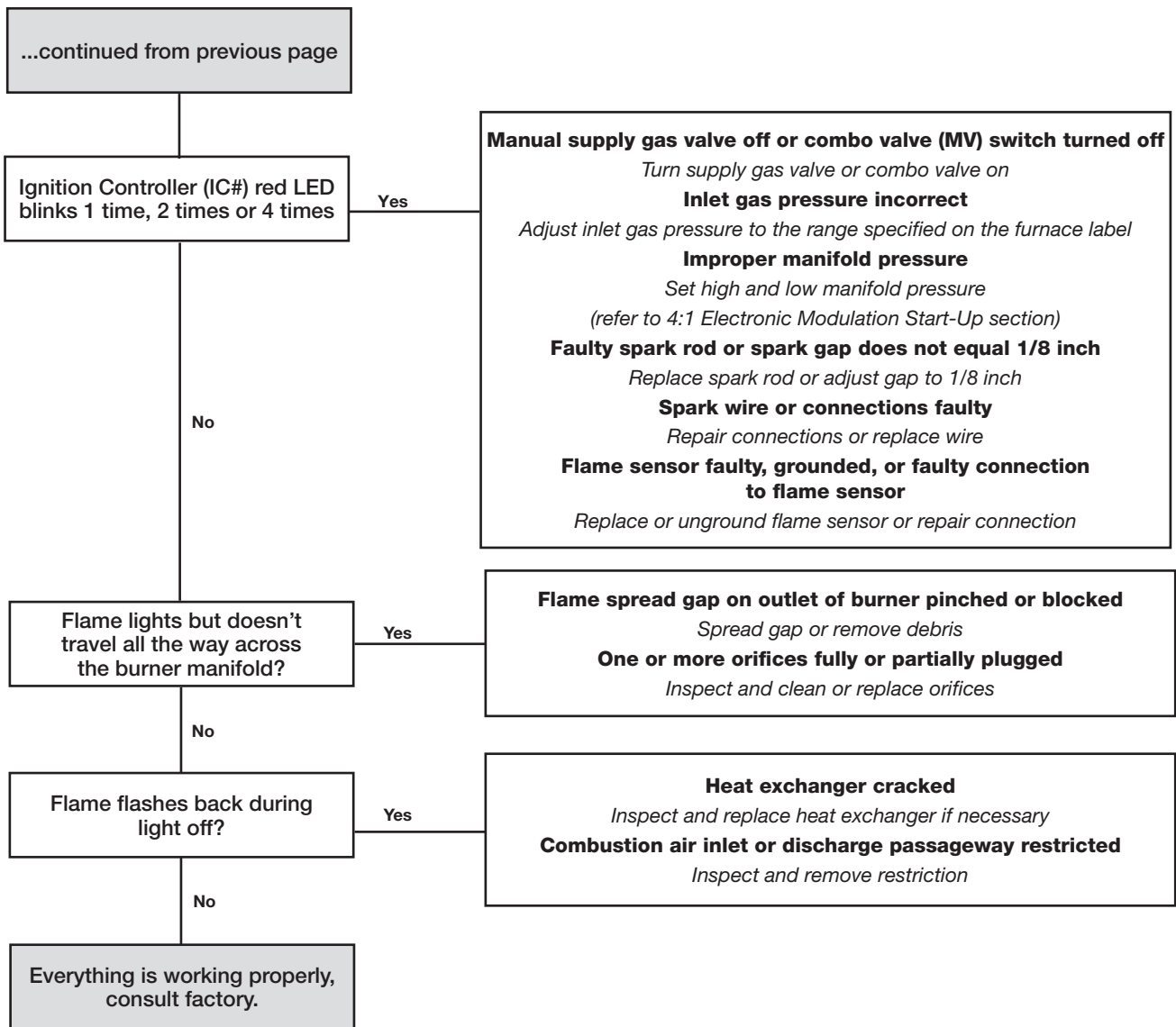

Reference - Controls

Furnace Control with Microprocessor Control

If the unit is equipped with a microprocessor control, the expansion board acts as an interface between the microprocessor controller and the furnace. In this case, the pCOe has no logic built into it since the logic is already contained in the microprocessor controller. On this type of controller, the LED status lights show the following:

LED Color	Status	Significance
Yellow	Powered	The pCOe has power.
Red	Error	The pCOe is not connected to the microprocessor controller. Check connection and the microprocessor controller power.
Green	Operational	The pCOe has power and is connected to the microprocessor controller.

If the controller detects a fault, it will go into alarm mode and a message code will appear on the microprocessor controller. Message codes that may appear include:

Alarm Descriptions	
IG furnace no flame after three trials	Indicates a furnace failure to light or properly sense flame after 3 trials.
IG combustion fan high pressure switch failure	Indicates a call for high speed combustion fan but high pressure switch did not close.
IG furnace ignition control	Indicates an alarm from the ignition controller.
Pressure switch closed with combustion fan off	Indicates low pressure switch was closed with no call for combustion fan.
Combustion fan not proved	Indicates a call for low speed combustion fan but low pressure switch did not close.
IG furnace max retry	Indicates that the max number of retries was reached.
High temp. alarm pressure fault with excessive discharge temp. Check for high limit trip.	Indicates upon a pressure fault, there was a high discharge temperature which could indicate a high limit trip.
IG furnace offline	Indicates communication with furnace control has failed.



Maintenance

Combustion Blower Motor

Motor maintenance is generally limited to cleaning. Cleaning should be limited to exterior surfaces only. Removing dust and grease build-up on the motor housing assures proper motor cooling. Use caution and do not allow water or solvents to enter the motor or bearings. Under no circumstances should motors or bearings be sprayed with water, steam or solvents. The motor bearings are pre-lubricated and sealed, requiring no further lubrication.

WARNING

Turn off all gas and electrical power to the unit before performing any maintenance or service operations to this unit. Remember that if the unit is equipped with electric heat, there may be a second high voltage source that must also be disconnected.

Burners and Orifices

Before each heating season, examine the burners and gas orifices to make sure they are clear of any debris such as spider webs, etc. Clean burner as follows:

- Turn off both electrical and gas supplies to the unit.
- Disconnect the union between manifold and gas valve.
- Remove burner manifold and burner assembly.
- Inspect and clean orifices and burners as necessary. Avoid using any hard or sharp instruments which could cause damage to the orifices or burners.
 - a. Remove any soot deposits from the burner with a wire brush.
 - b. Clean the ports with an aerosol degreaser or compressed air.
 - c. Wipe the inside of the burner clean. Cleaning the burner with a degreaser will slow the future buildup of dirt.
- Before reinstalling the burner assembly, look down the heat exchanger tubes to make sure they are clear of any debris.
- Reinstall manifold and burner assembly, reconnect wire leads and gas supply piping.
- Turn on the electrical power and gas supply.
- Follow the start-up procedure to light the burners and verify proper operation.

Heat Exchanger

The heat exchanger should be checked annually for cracks and discoloration of the tubes. If a crack is detected, the heat exchanger should be replaced before the unit is put back into operation. If the tubes are dark gray, airflow across the heat exchanger should be checked to make sure the blower is operating properly.

Flue Collector Box

The flue passageway and flue collector box should be inspected prior to each heating season and cleared of any debris.

Electrical Wiring

The electrical wiring should be inspected annually for loose connections or wiring deterioration.

Gas Train

The gas train connections, joints and valves should be checked annually for tightness.

Replacement Parts

When ordering replacement parts, include the complete unit model number and serial number as shown on the unit labels.



Maintenance Log

Date _____ Time _____ AM/PM

Notes: _____

Date _____ Time _____ AM/PM

Notes: _____

Date _____ Time _____ AM/PM

Notes: _____

Date _____ Time _____ AM/PM

Notes: _____

Date _____ Time _____ AM/PM

Notes: _____

Date _____ Time _____ AM/PM

Notes: _____

Date _____ Time _____ AM/PM

Notes: _____

Date _____ Time _____ AM/PM

Notes: _____

Date _____ Time _____ AM/PM

Notes: _____

Date _____ Time _____ AM/PM

Notes: _____

Date _____ Time _____ AM/PM

Notes: _____

Date _____ Time _____ AM/PM

Notes: _____



Our Commitment

As a result of our commitment to continuous improvement, Accurex reserves the right to change specifications without notice.

Specific Accurex product warranties are located on accurex.com within the product area tabs and in the Library under Warranties.



P.O. Box 410 Schofield, WI 54476
Phone: 800.333.1400 • Fax: 715.241.6191
Parts: 800.355.5354 • www.accurex.com